

# Aero Baffles





Sleek and minimal, Aero Baffles are versatile acoustic solutions that will transform any space they occupy. Suspend these baffles from the ceiling to see and hear what a difference they make.



# How to Specify

Step by step instructions on how to specify Aero Baffles.

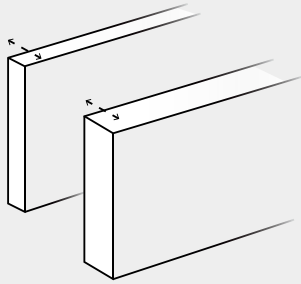

01

**Choose thickness.**  
(pg 03)

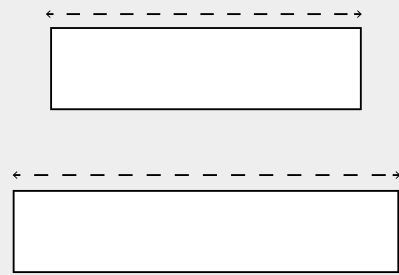

02

**Choose baffle size.**  
(pg 03)

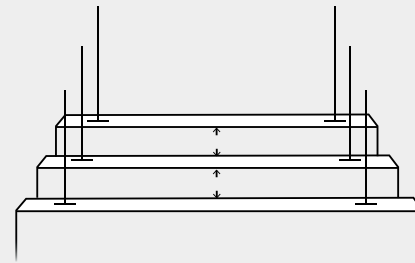

03

**Choose baffle spacing.**  
(pg 04)

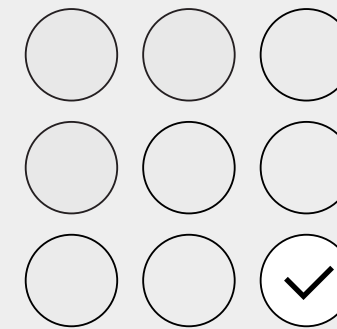

04

**Choose colour.**  
(pg 05)

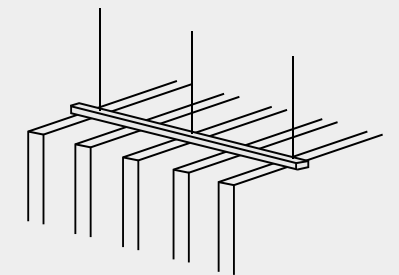

05

**Choose installation method.**  
(pg 06-07)

# Dimensions

## Standard Dimensions (mm)

1220 L x 305 H

2440 L x 305 H

2745 L x 305 H

## Standard Thicknesses (mm)

12, 18, 24

## Edge Detail



Square Edge

## Corner Detail



Filleted Corner (Standard)



Square Corner (Optional)

## Customization

Length and Height can be customized to fit your space.

### Small

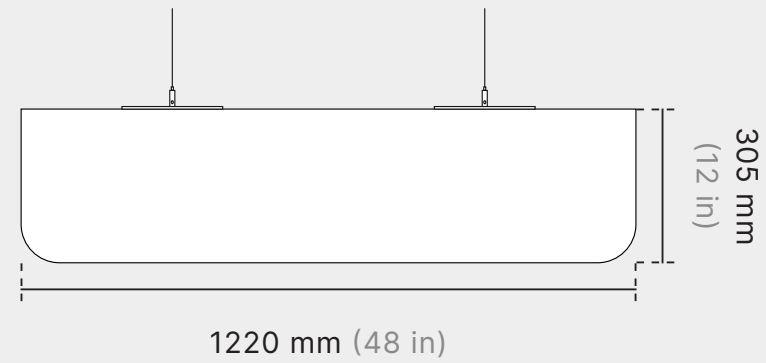

### Medium

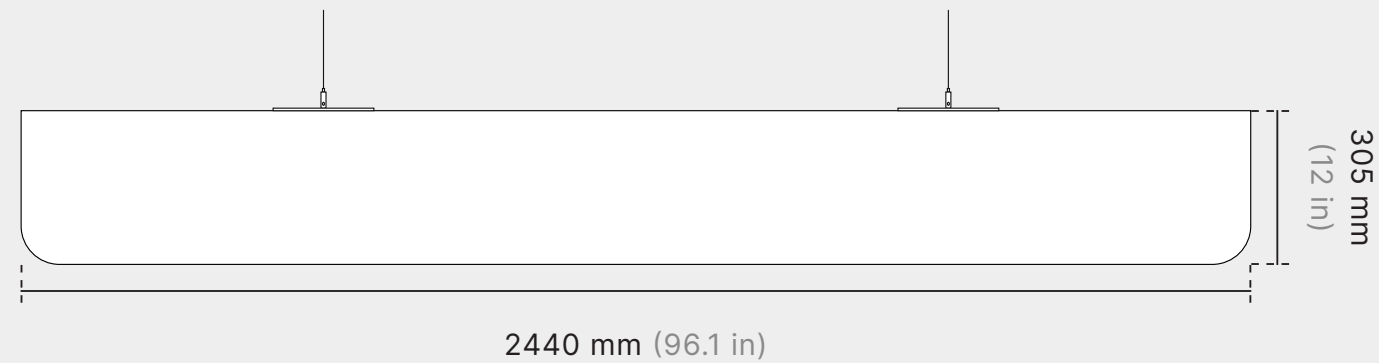

### Large

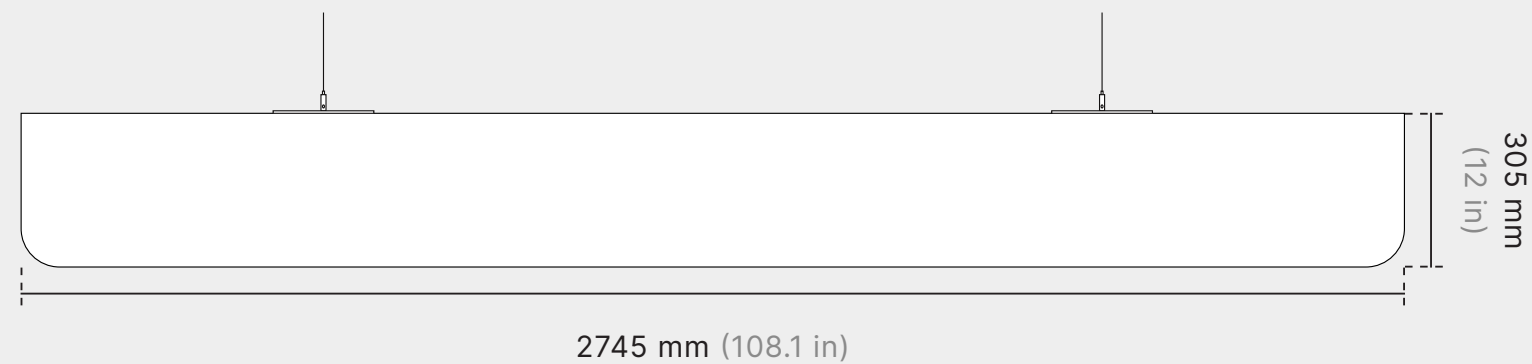

# Spacing

Aero Baffles in a cloud configuration makes installation a breeze.

Choose from the following standard spacing options.

**102 mm Spacing (O.C.)**

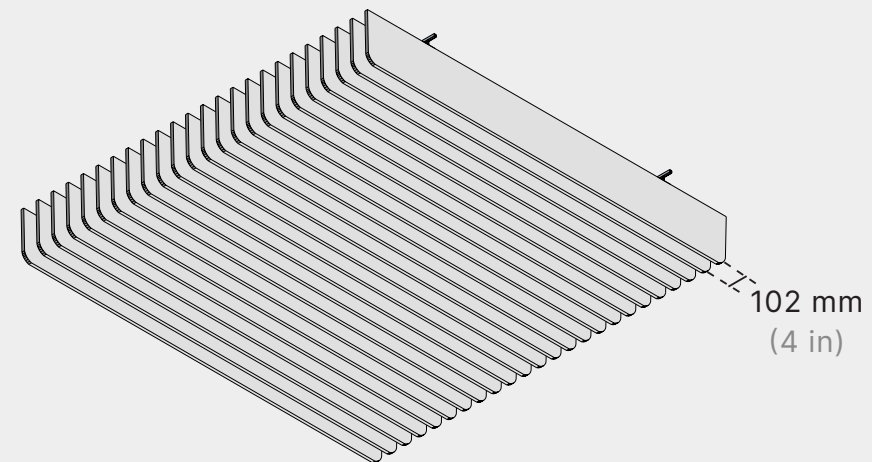

**153 mm Spacing (O.C.)**

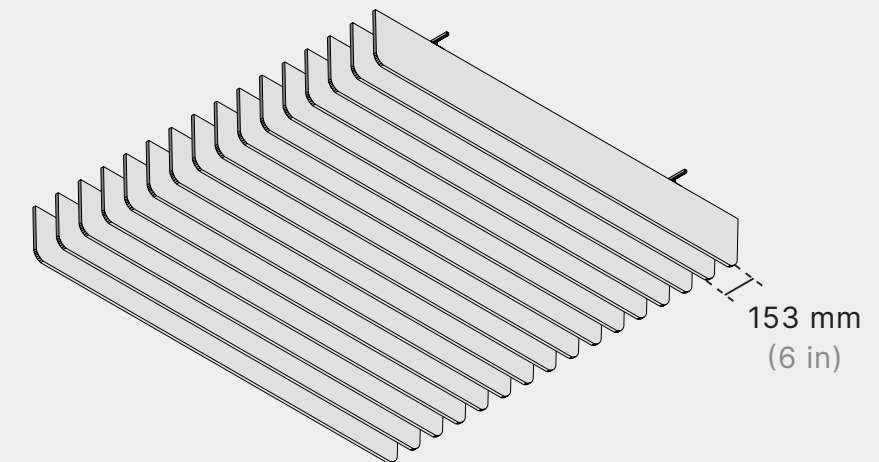

**203 mm Spacing (O.C.)**

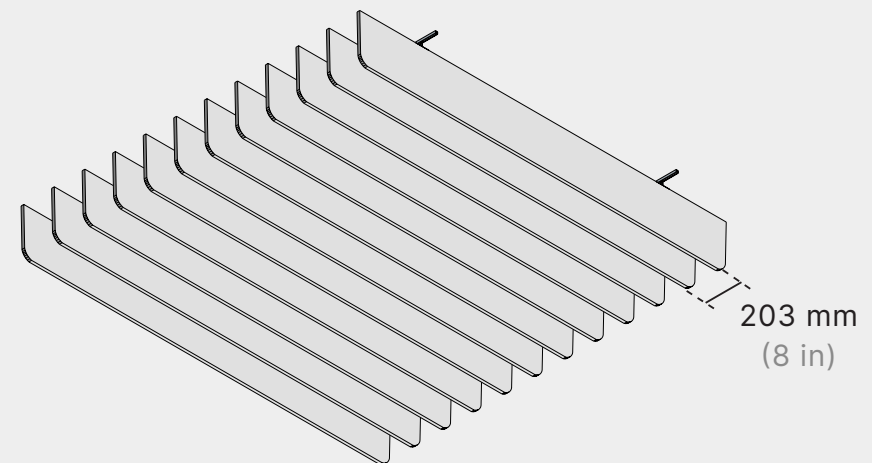

**305 mm Spacing (O.C.)**

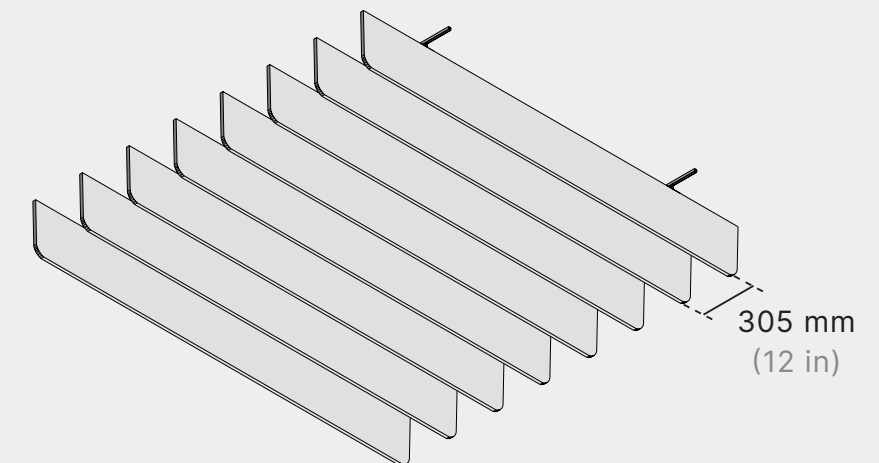

---

## Customization

Custom spacing available.

# Standard Colours

Choose from any one of our standard colours.



**Pure White**  
SP 07



**Urban Grey**  
SP 79

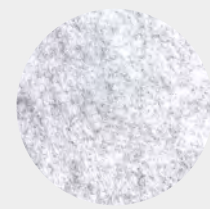

**Pumice**  
SP 11



**Warm Grey**  
SP 76

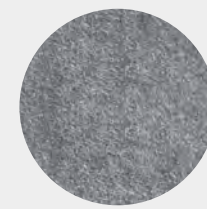

**Cool Grey**  
SP 36

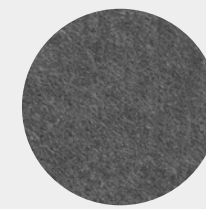

**Mid Grey**  
SP 37

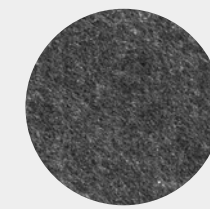

**Graphite**  
SP 03

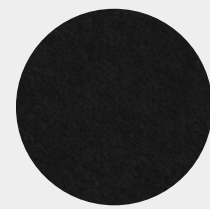

**Black**  
SP 13



**Ivory**  
SP 77



**Beige**  
SP 04



**Sandstone**  
SP 12

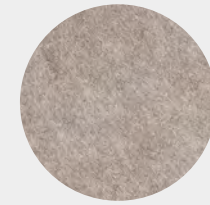

**Taupe Grey\***  
SP 90

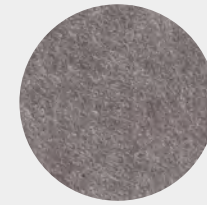

**Castlerock\***  
SP 80

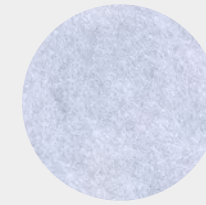

**Krypton**  
SP 30



**Purple**  
SP 50

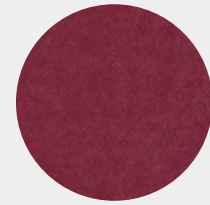

**Plum**  
SP 72

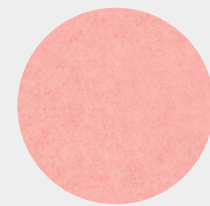

**Blush Pink**  
SP 81

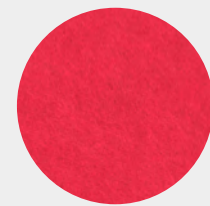

**Red**  
SP 08

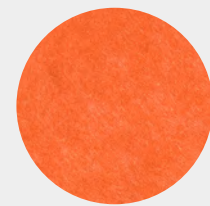

**Orange**  
SP 46

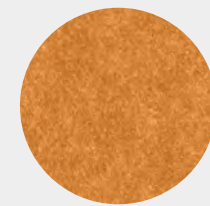

**Yam**  
SP 28

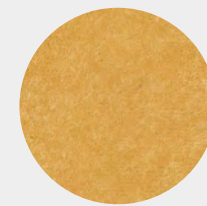

**Mustard\***  
SP 87

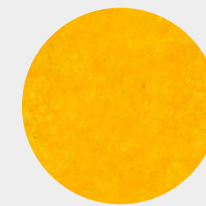

**Sunflower**  
SP 05

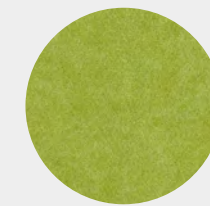

**Chartreuse**  
SP 43

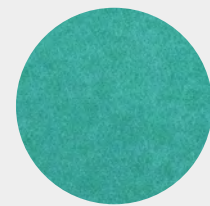

**Aquamarine**  
SP 73

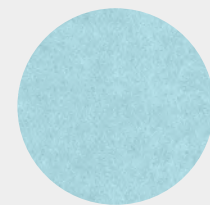

**Pale Teal**  
SP 74

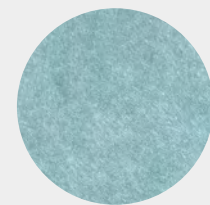

**Lagoon\***  
SP 84

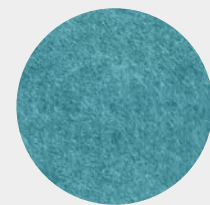

**Dark Turquoise**  
SP 71

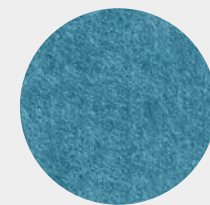

**Azure\***  
SP 85

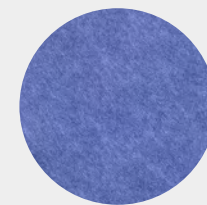

**Sky Blue**  
SP 25



**Navy**  
SP 01



**Deep Sea Blue\***  
SP 83



**Midnight Blue**  
SP 19

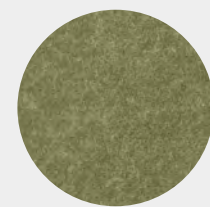

**Olive\***  
SP 88

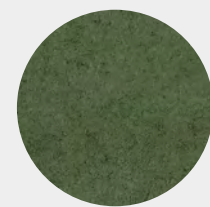

**Moss\***  
SP 89

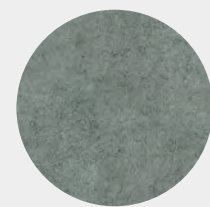

**Desert Sage**  
SP 78

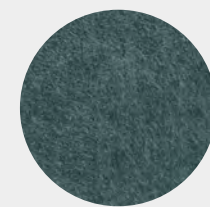

**Peacock\***  
SP 82

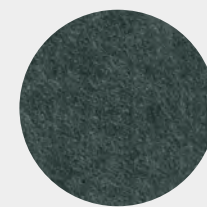

**Ocean Green\***  
SP 86



**Forest Green**  
SP 17

Don't see something you love? Ask us about creating your own custom colour.

All colours available in 9, 12, 18, and 24 mm unless noted otherwise.

\* 12 mm / 24 mm only

# Installation Option 01

## Baffle Cloud Suspension Kit

Baffles are attached to channels and suspended in an array.

- Reduces the number of hanging points on the ceiling
- Hanging points can be moved along the channels

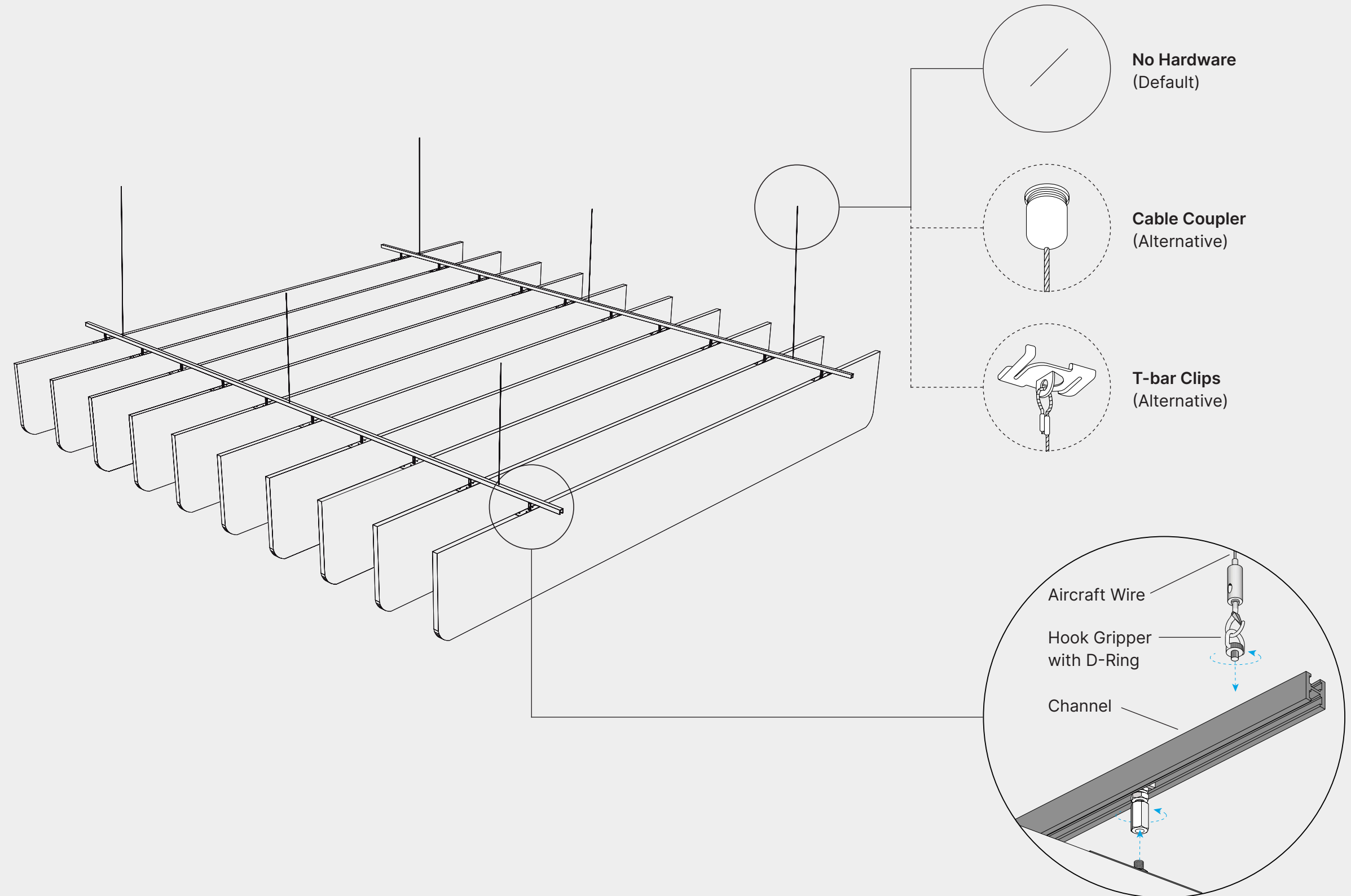

# Installation Option 02

## Individual Baffle Suspension Kit

Each baffle is suspended by its own set of aircraft wires.

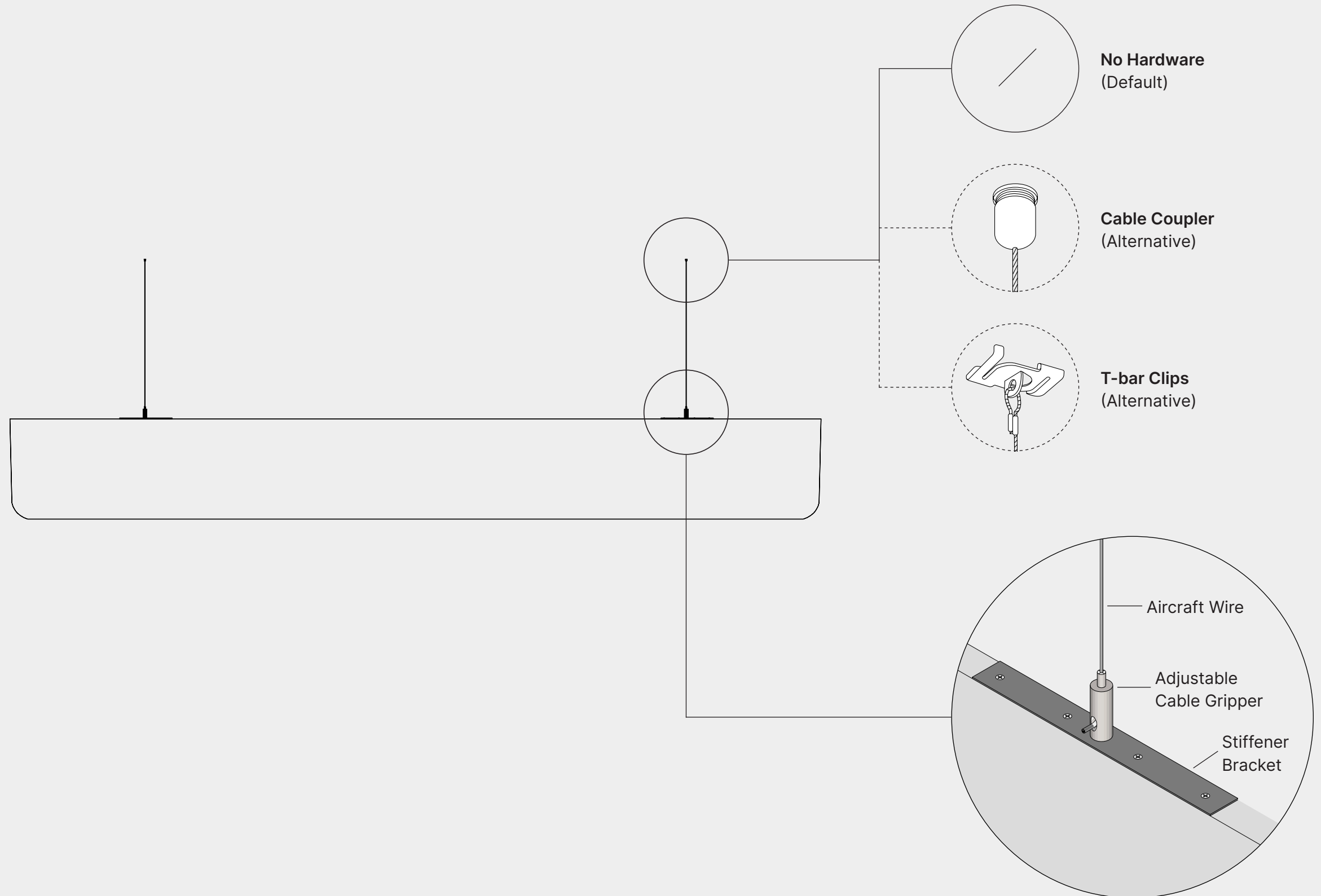



# Product Specifications

## Aero Baffles

### Composition

100% polyester fibre

### VOC Emissions

CDPH (CA 01350)

### Antimicrobial Testing

Mould & mildew resistant

### Fire Rating

- ASTM E84 Class A
- CAN/ULC-S102.2-10

### Sustainability

- 100% recyclable
- LBC Red List free
- Contributes to LEED certification
- Free of toxic substances and of off-gassing
- Made with ~60% recycled content from plastic water bottles

### Colour & Texture Variations

The felting and dyeing process that forms the material contributes to its unique texture but also to variations in texture and colour from panel to panel. Products will be provided within an acceptable range of variation.



# Sound Absorption Graph

The following values reflect the acoustic properties of the product as tested in accordance with ASTM C423-09a.

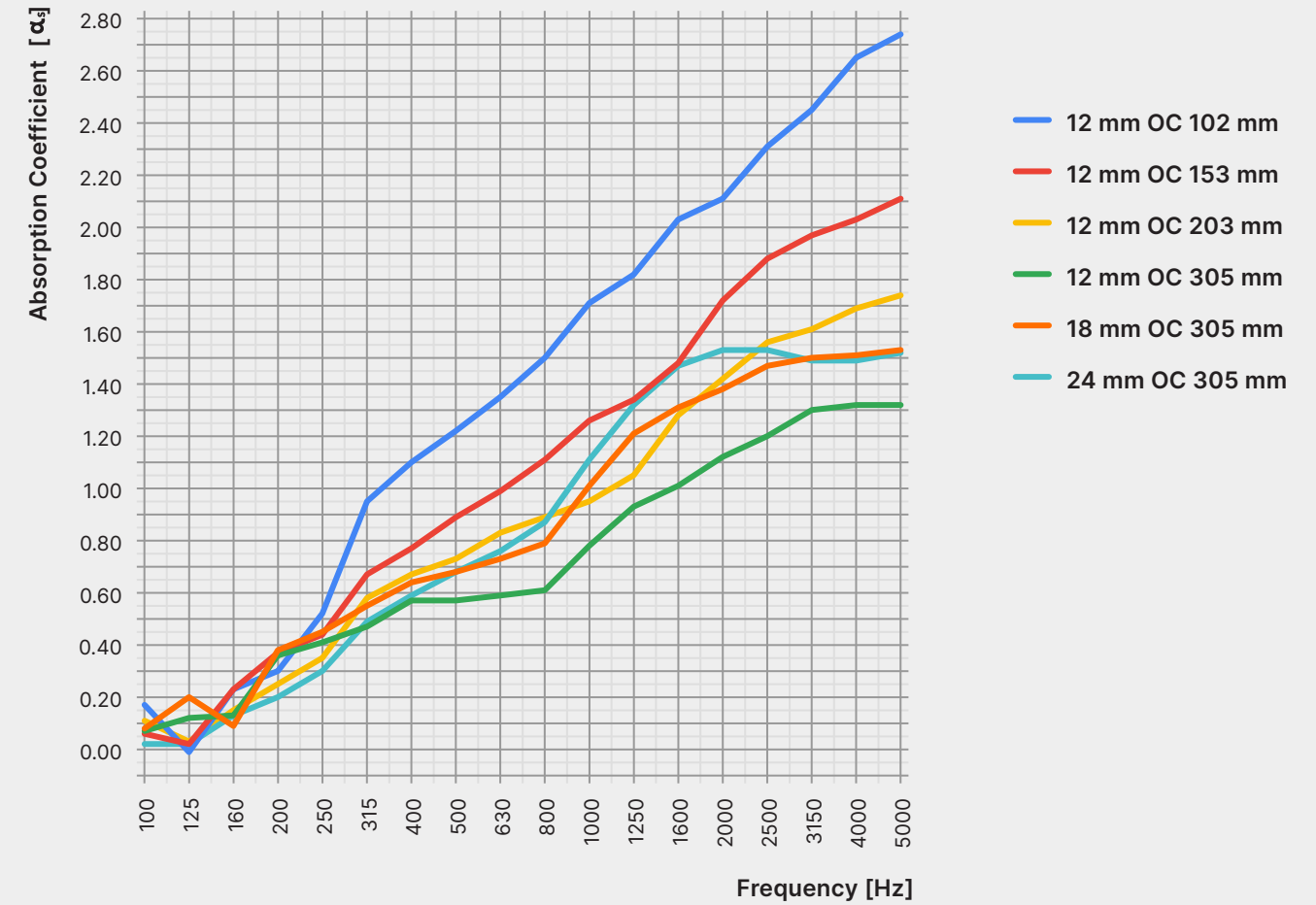

	200	250	315	400	500	630	800	1000	1250	1600	2000	2500	NRC	SAA
<b>12 mm OC 102 mm</b>	0.30	0.52	0.95	1.10	1.22	1.35	1.50	1.71	1.82	2.03	2.11	2.31	1.40	1.41
<b>12 mm OC 153 mm</b>	0.37	0.44	0.67	0.77	0.89	0.99	1.11	1.26	1.34	1.48	1.72	1.88	1.10	1.08
<b>12 mm OC 203 mm</b>	0.25	0.35	0.58	0.67	0.73	0.83	0.89	0.95	1.05	1.28	1.42	1.56	0.85	0.88
<b>12 mm OC 305 mm</b>	0.36	0.41	0.47	0.57	0.57	0.59	0.61	0.78	0.93	1.01	1.12	1.20	0.70	0.72
<b>18 mm OC 305 mm</b>	0.38	0.45	0.55	0.64	0.68	0.73	0.79	1.01	1.21	1.31	1.38	1.47	0.90	0.88
<b>24 mm OC 305 mm</b>	0.20	0.30	0.49	0.59	0.68	0.76	0.87	1.11	1.32	1.47	1.53	1.53	0.90	0.90

# Product Care

---

## Handling & Storage

Handle products with care so as to avoid folding the polyester felt, chipping its edges, or indenting its faces. Store products in their original containers in a well-ventilated area until the intended application environment is ready for installation. Allow products to acclimatize to environmental conditions. Lay them flat on their faces; do not stand them on their edges. Protect from moisture, heat, direct sunlight, and the elements.

---

## Warranty

AKUSTUS warrants the construction and finish of all our products to be free from defects in material and workmanship for a period of 1 year from the date of purchase.

---

## Maintenance

Lightly brush or gently vacuum to remove dust from polyester felt. Clean with warm water and mild, non-toxic soap to remove spills. Test solution on an inconspicuous spot before applying to more visible areas. Blot with a dry cloth after applying the solution to avoid saturating the material. Avoid applying too much pressure when cleaning the products.

AERO

BAFFLES

AKUSTUS.COM