

# Stripes Ceiling Tiles

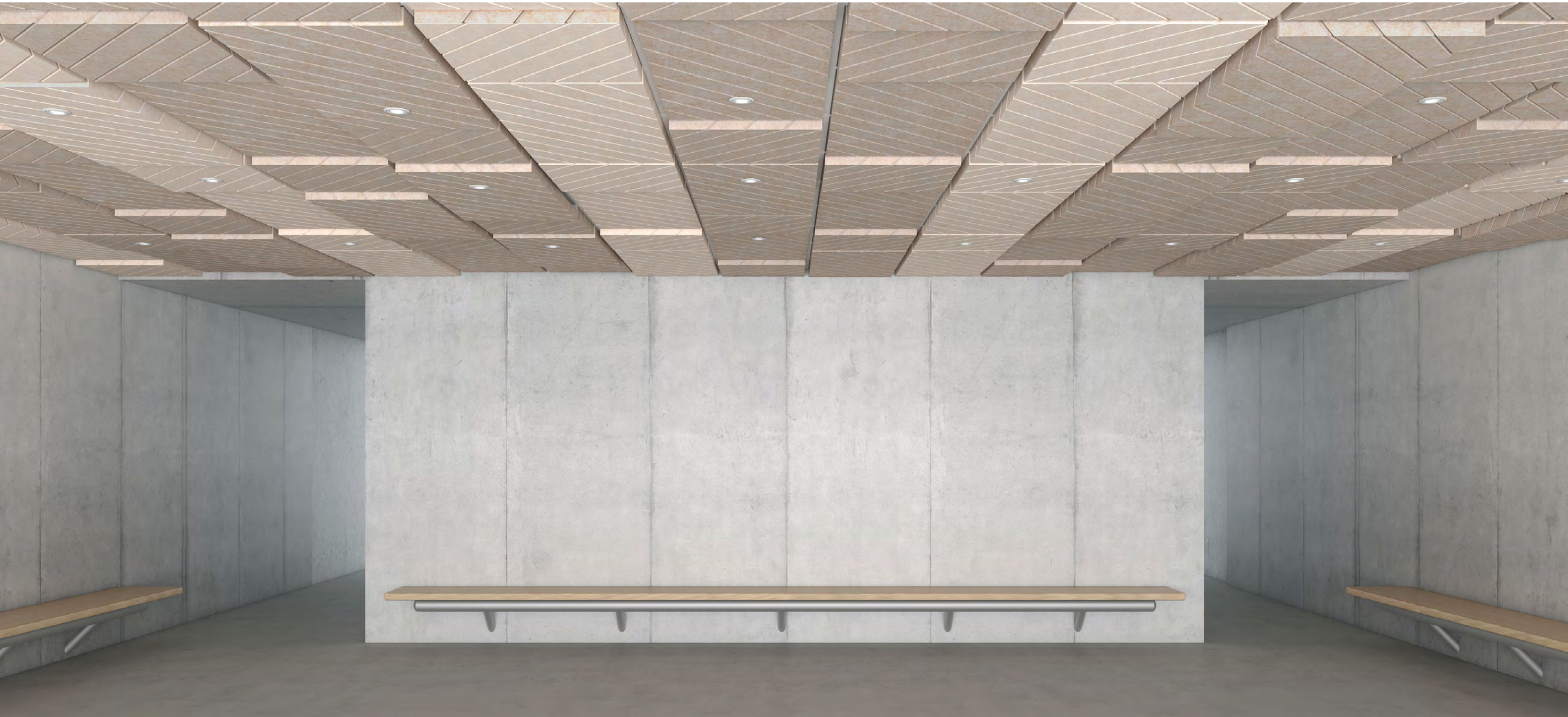



Stripes Ceiling Tiles showcase the timeless appeal of simple patterns formed by parallel lines. Where most ceiling tiles are made with only acoustic benefits in mind, these tiles are fashioned to provide aesthetic appeal as well. Flat and flush with the ceiling or protruding from the ceiling in the shape of a box, these tiles can be placed in a ceiling grid system to transform an office in the middle of downtown or a store in the middle of a shopping mall.

# How to Specify

Step by step instructions on how to specify [Stripes Ceiling Tiles](#).

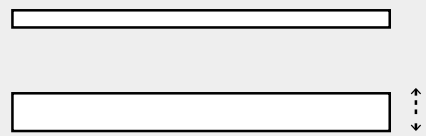

**01**

**Choose edge variation.**  
(pg 03)

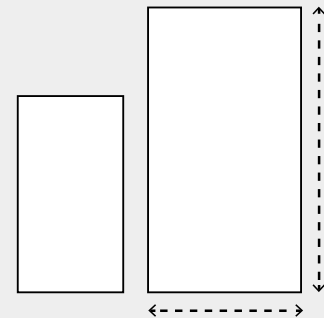

**02**

**Choose panel size.**  
(pg 04)

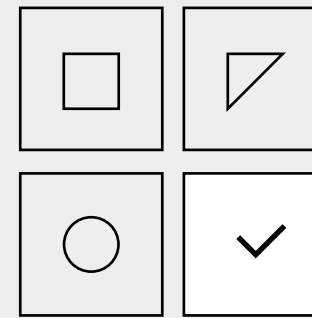

**03**

**Option A**  
Choose panel design and create your own configuration.

**Option B**  
Choose one of our configurations.  
(pg 05-06)

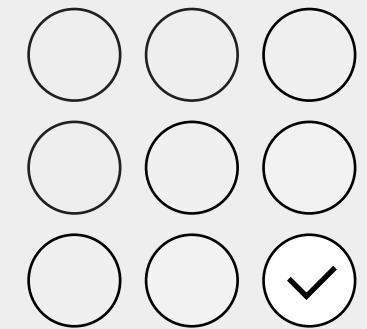

**04**

**Choose colour.**  
(pg 07)

# Edge Variations

Choose from 3 different edges. No matter the variation, the panel will easily lay in to a standard T-grid system.

### Square Edge

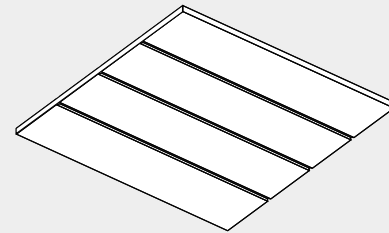

### Tegular Edge

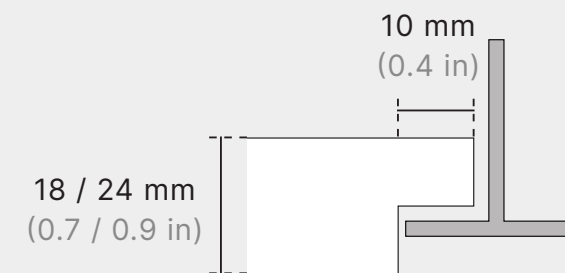
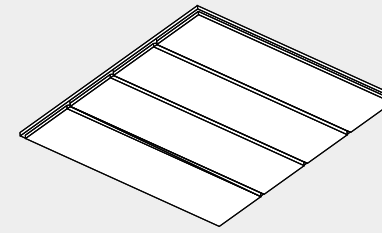

### Box Edge

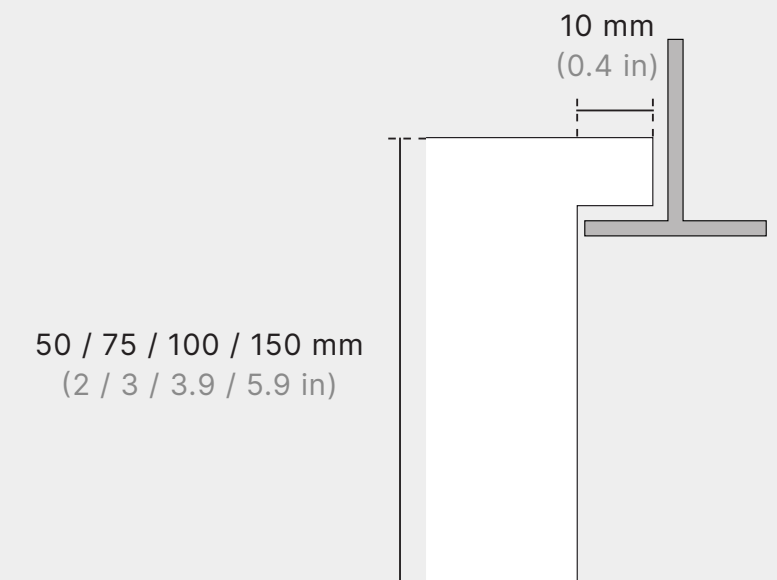
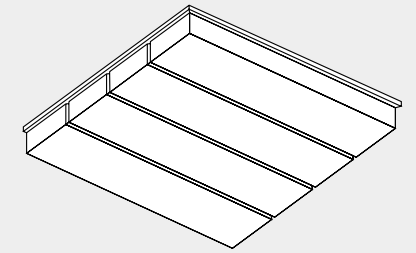

#### Standard Thicknesses (mm)

**Square** 12, 18, 24

**Tegular** 18, 24

**Box** 50, 75, 100, 150

# Dimensions

## Square

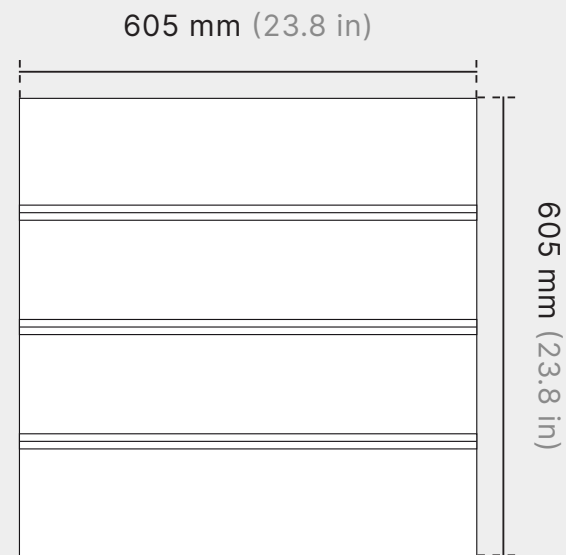

\* Square Edge option, Stripes A design shown here

## Rectangle

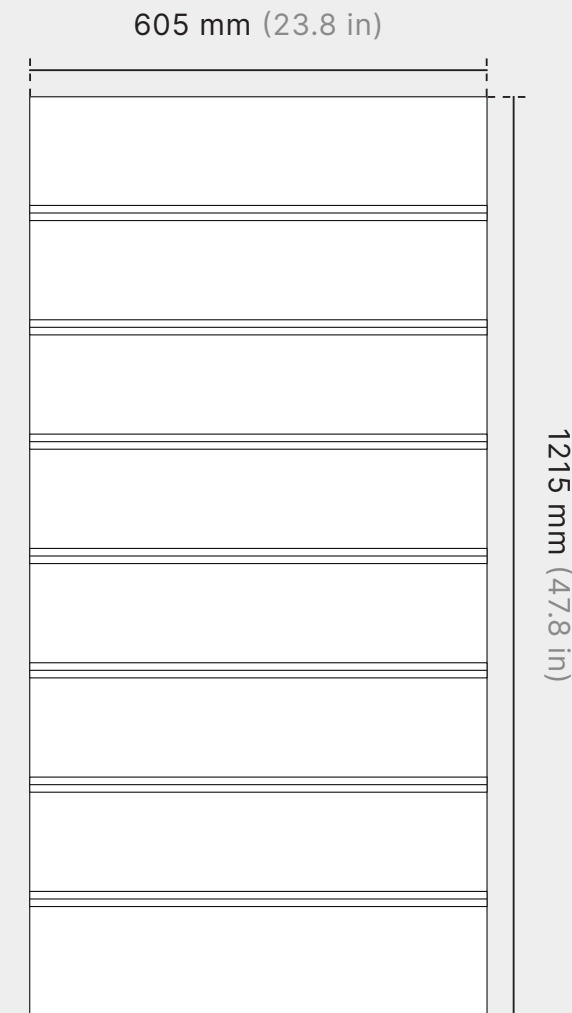

### Standard Dimensions (mm)

605 W x 605 L

605 W x 1215 L

### Customization

Width and Length can be customized to fit your space.

# Panel Designs

Stripes come in 3 standard design variations.

Design A

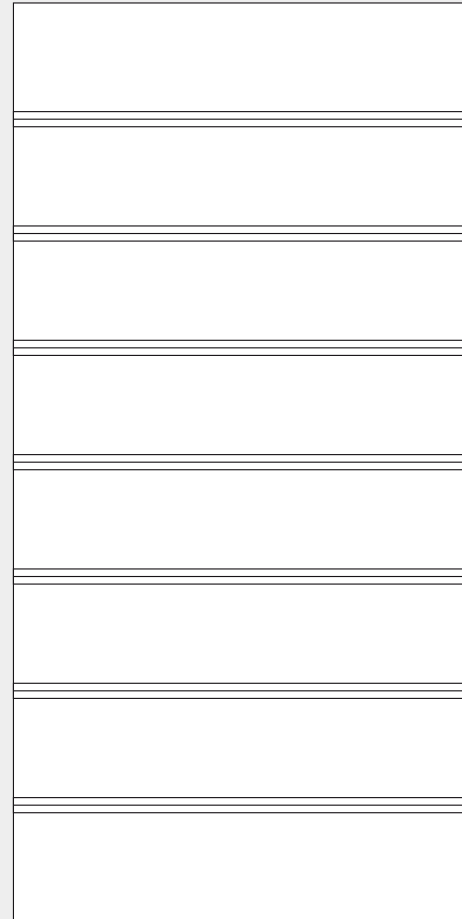

Design B

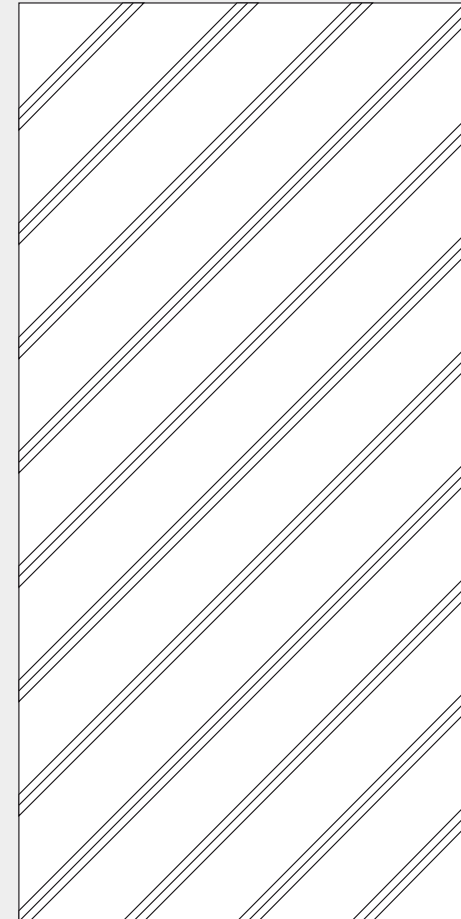

Design C

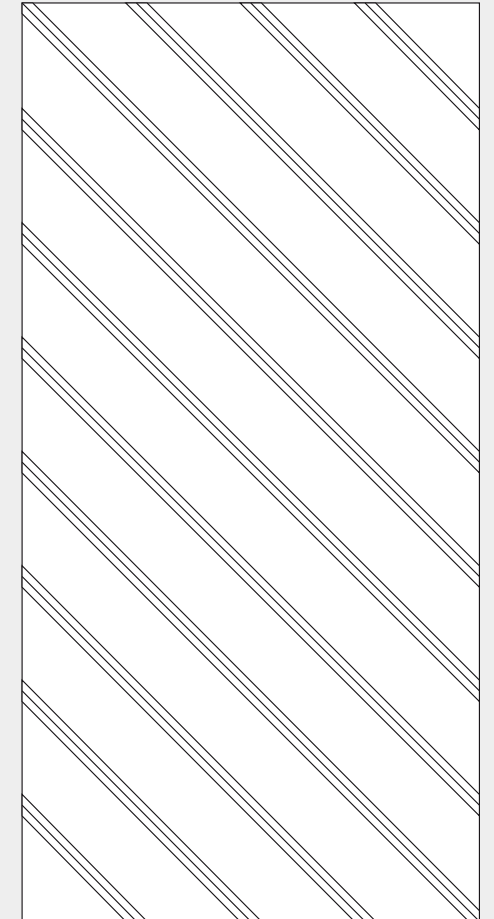

---

## Customization

Custom pattern, shape, and size available.

# Configurations

Examples of how the panels can be arranged.

**Config 1**

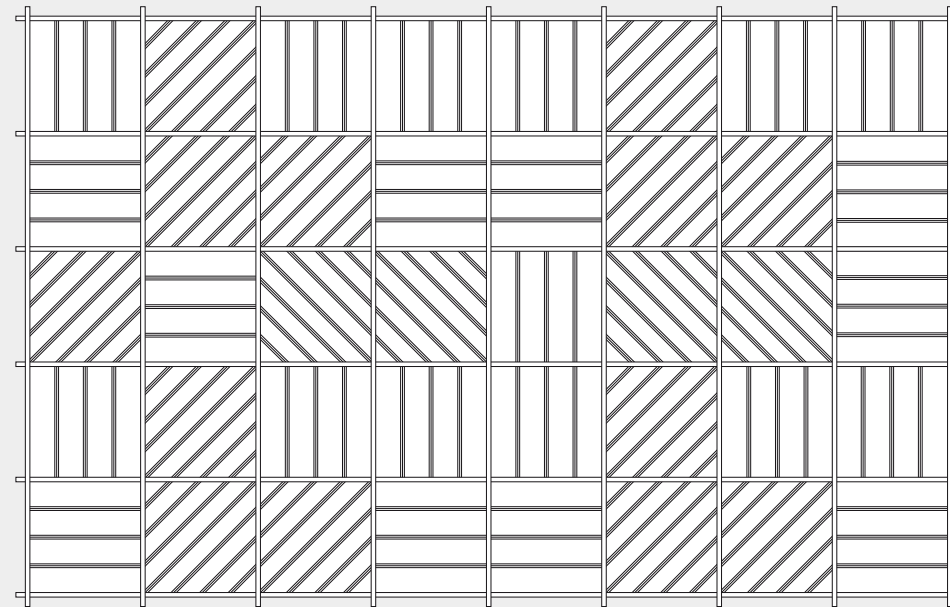

**Config 2**

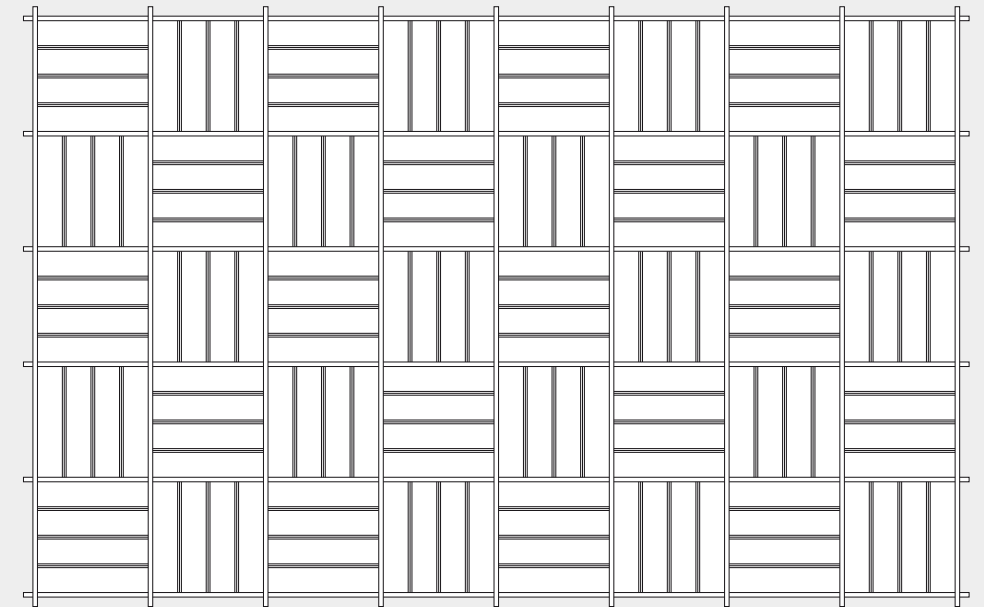

**Config 3**

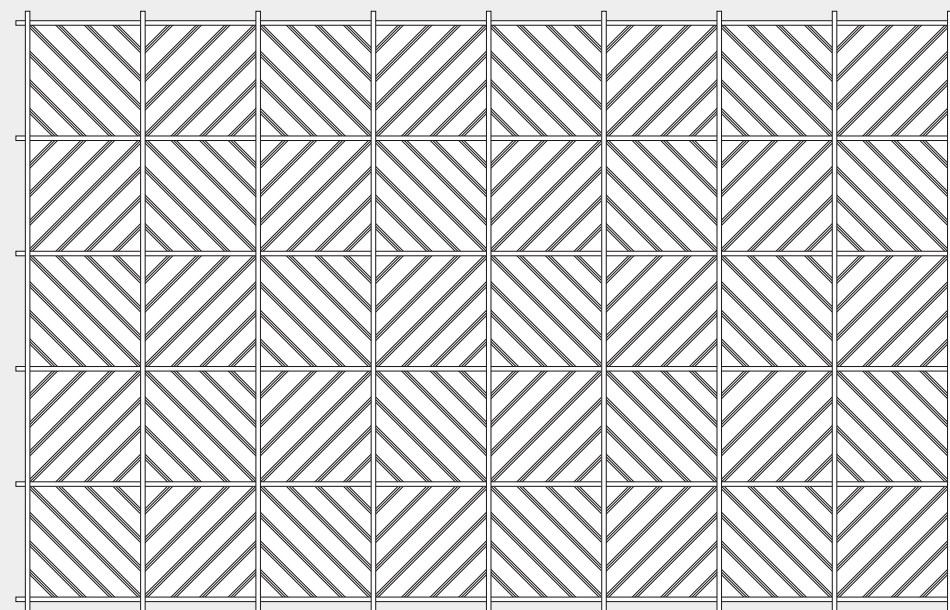

# Standard Colours

Choose from any one of our standard colours.



**Pure White**  
SP 07



**Urban Grey**  
SP 79

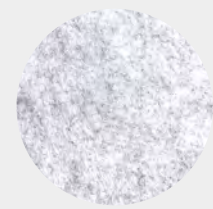

**Pumice**  
SP 11

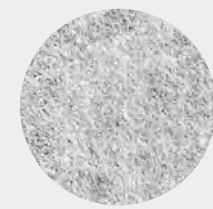

**Warm Grey**  
SP 76

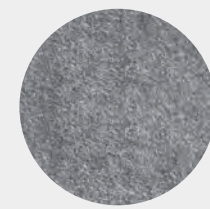

**Cool Grey**  
SP 36

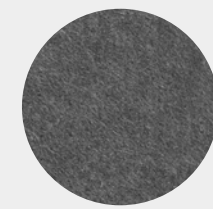

**Mid Grey**  
SP 37

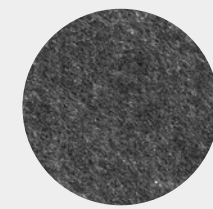

**Graphite**  
SP 03

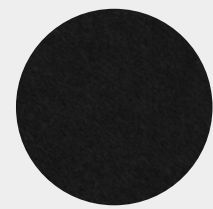

**Black**  
SP 13



**Ivory**  
SP 77



**Beige**  
SP 04



**Sandstone**  
SP 12

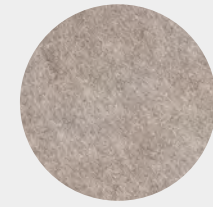

**Taupe Grey\***  
SP 90

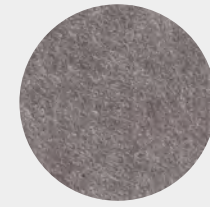

**Castlerock\***  
SP 80

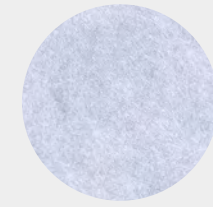

**Krypton**  
SP 30



**Purple**  
SP 50



**Plum**  
SP 72

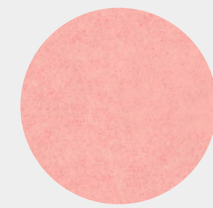

**Blush Pink**  
SP 81

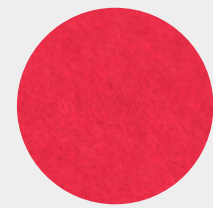

**Red**  
SP 08

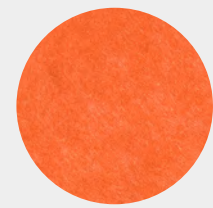

**Orange**  
SP 46

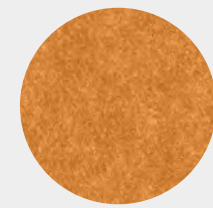

**Yam**  
SP 28

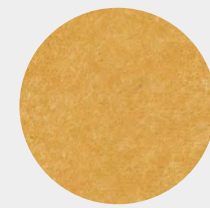

**Mustard\***  
SP 87

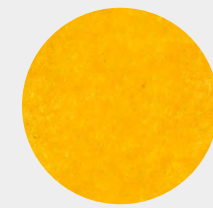

**Sunflower**  
SP 05

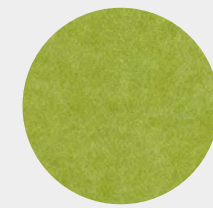

**Chartreuse**  
SP 43

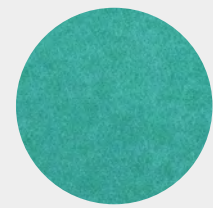

**Aquamarine**  
SP 73

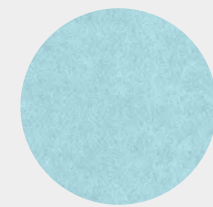

**Pale Teal**  
SP 74

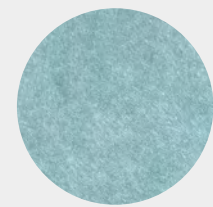

**Lagoon\***  
SP 84

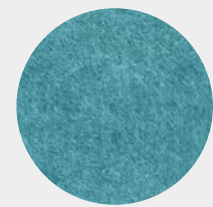

**Dark Turquoise**  
SP 71

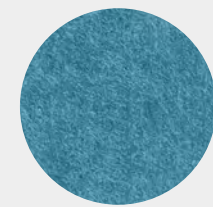

**Azure\***  
SP 85

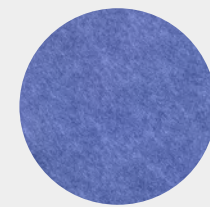

**Sky Blue**  
SP 25

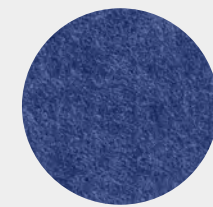

**Navy**  
SP 01



**Deep Sea Blue\***  
SP 83



**Midnight Blue**  
SP 19

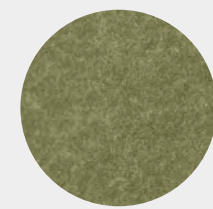

**Olive\***  
SP 88

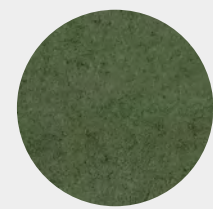

**Moss\***  
SP 89



**Desert Sage**  
SP 78

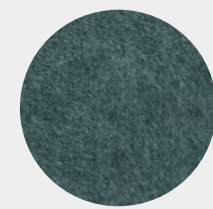

**Peacock\***  
SP 82

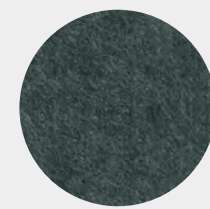

**Ocean Green\***  
SP 86



**Forest Green**  
SP 17

STRIPES

CEILING TILES

AKUSTUS.COM

Don't see something you love? Ask us about creating your own custom colour.

All colours available in 9, 12, 18, and 24 mm unless noted otherwise.

\* 12 mm / 24 mm only



# Product Specifications

## Stripes Ceiling Tiles

### Composition

100% polyester fibre

### VOC Emissions

CDPH (CA 01350)

### Antimicrobial Testing

Mould & mildew resistant

### Fire Rating

- ASTM E84 Class A
- CAN/ULC-S102.2-10

### Sustainability

- 100% recyclable
- LBC Red List free
- Contributes to LEED certification
- Free of toxic substances and of off-gassing
- Made with ~60% recycled content from plastic water bottles

### Colour & Texture Variations

The felting and dyeing process that forms the material contributes to its unique texture but also to variations in texture and colour from panel to panel. Products will be provided within an acceptable range of variation.



# Sound Absorption Graph

The following values reflect the acoustic properties of the product as tested in accordance with ASTM C423-09a.

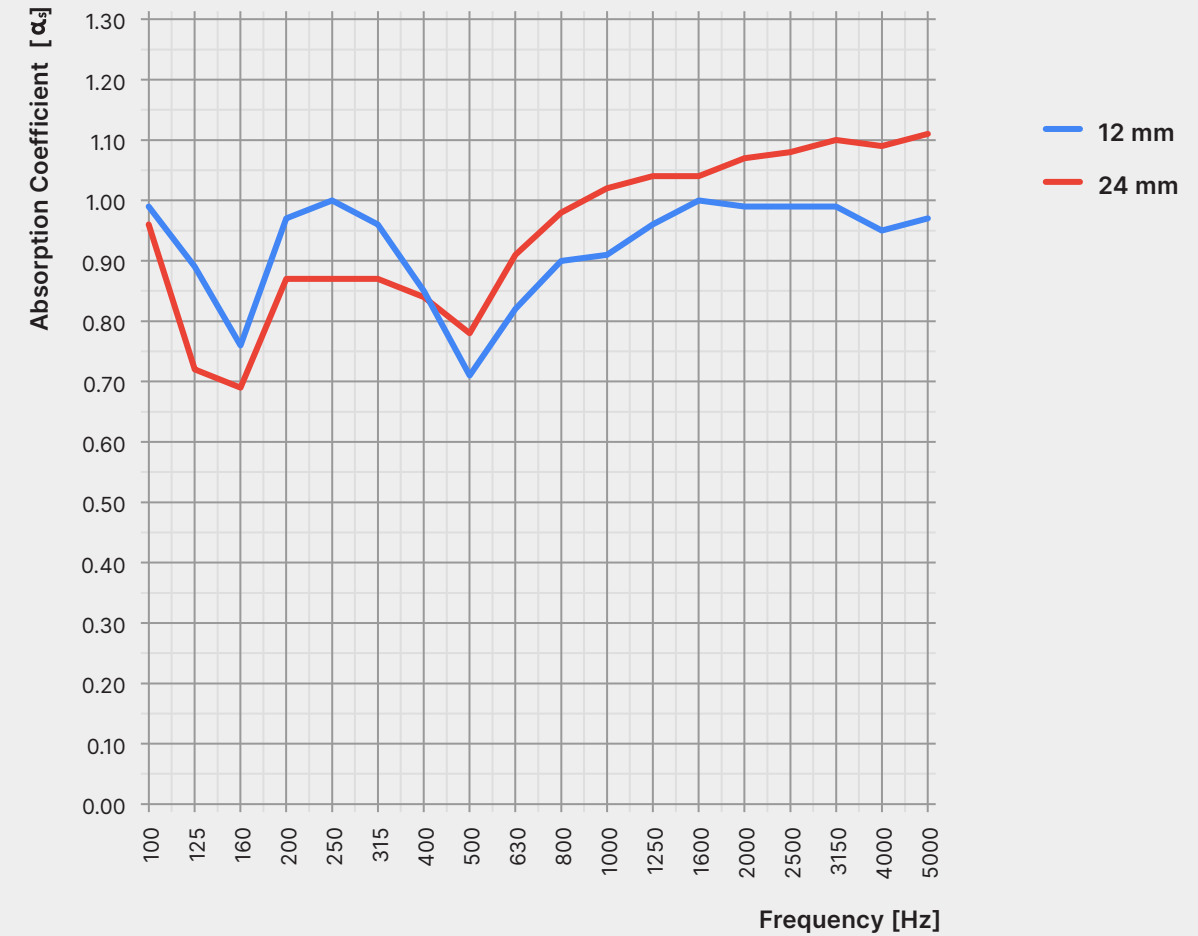

	200	250	315	400	500	630	800	1000	1250	1600	2000	2500	NRC	SAA
<b>12 mm</b>	0.97	1.00	0.96	0.85	0.71	0.82	0.90	0.91	0.96	1.00	0.99	0.99	0.90	0.92
<b>24 mm</b>	0.87	0.87	0.87	0.84	0.78	0.91	0.98	1.02	1.04	1.04	1.07	1.08	0.95	0.95

# Product Care

## Handling & Storage

Handle products with care so as to avoid folding the polyester felt, chipping its edges, or indenting its faces. Store products in their original containers in a well-ventilated area until the intended application environment is ready for installation. Allow products to acclimatize to environmental conditions. Lay them flat on their faces; do not stand them on their edges. Protect from moisture, heat, direct sunlight, and the elements.

## Warranty

AKUSTUS warrants the construction and finish of all our products to be free from defects in material and workmanship for a period of 1 year from the date of purchase.

## Maintenance

Lightly brush or gently vacuum to remove dust from polyester felt. Clean with warm water and mild, non-toxic soap to remove spills. Test solution on an inconspicuous spot before applying to more visible areas. Blot with a dry cloth after applying the solution to avoid saturating the material. Avoid applying too much pressure when cleaning the products.

