

Billow Baffles





The calm from watching ocean waves ebb and flow. The awe from seeing a canopy of rolling clouds. Evoke those feelings and set people at ease with the Billow Baffle. Assembled in the form of a cloud, each system can be effortlessly hung from the ceiling.

How to Specify

Step by step instructions on how to specify Billow Baffles.

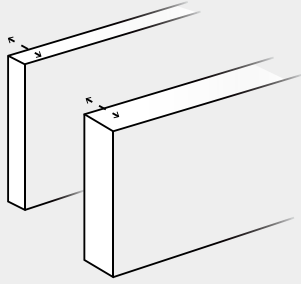

01

Choose thickness.
(pg 03)

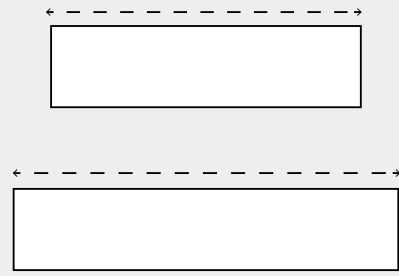

02

Choose baffle size.
(pg 03)

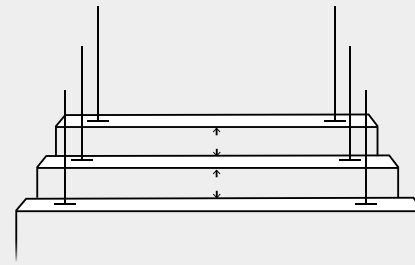

03

Choose baffle spacing.
(pg 04)

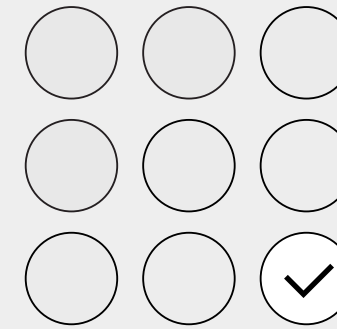

04

Choose colour.
(pg 05)

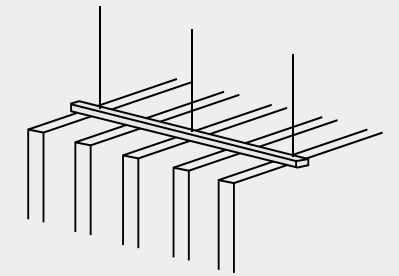

05

Choose installation method.
(pg 06-07)

Dimensions

Design A

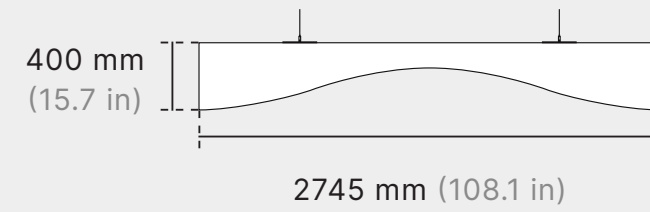

Design B

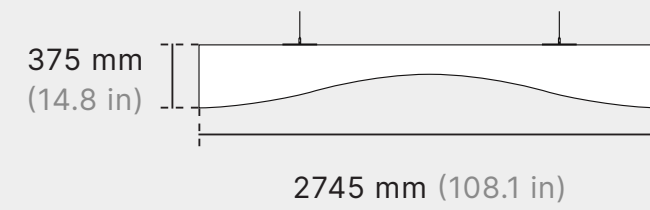

Design C

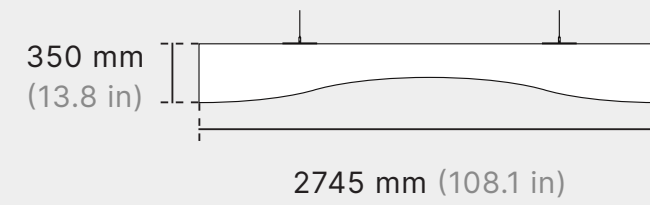

Design D

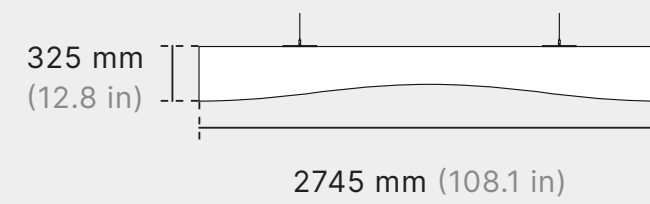

Design E

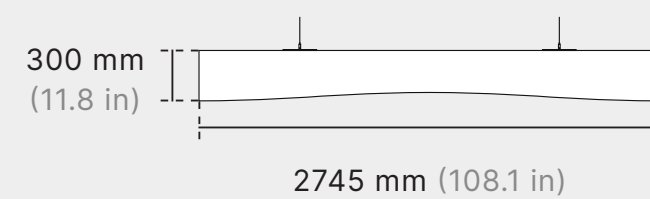

Design F



Design G

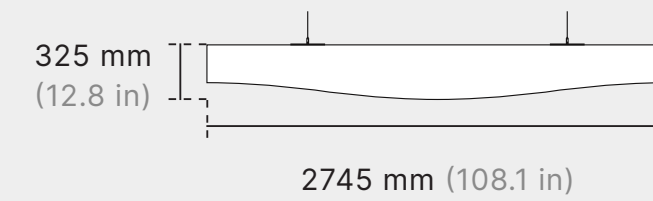

Design H

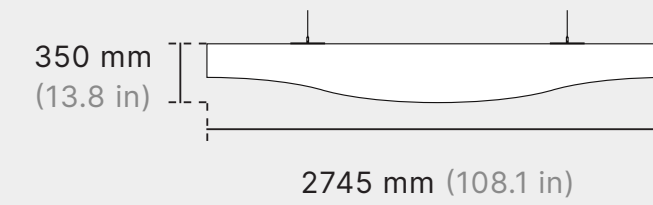

Design I

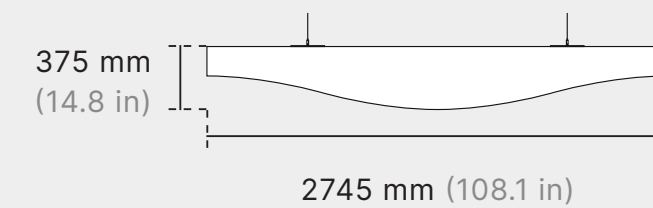

Design J

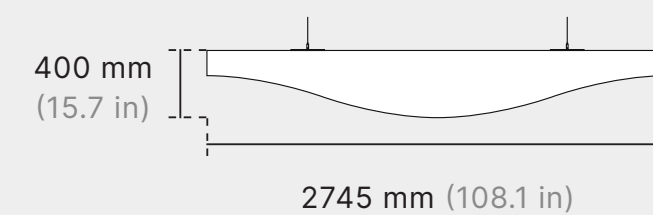

Standard Dimensions (mm)

2745 L x 400 H (max.)

Standard Thicknesses (mm)

12, 18, 24

Edge Detail

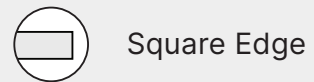

Customization

Length and Height can be customized to fit your space.

Spacing

Billow Baffles in a cloud configuration makes installation a breeze.

Choose from the following standard spacing options.

102 mm Spacing (O.C.)

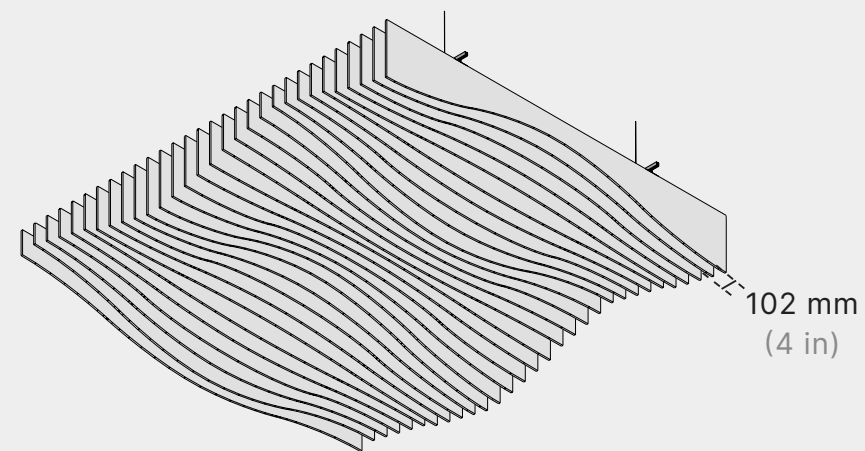

153 mm Spacing (O.C.)

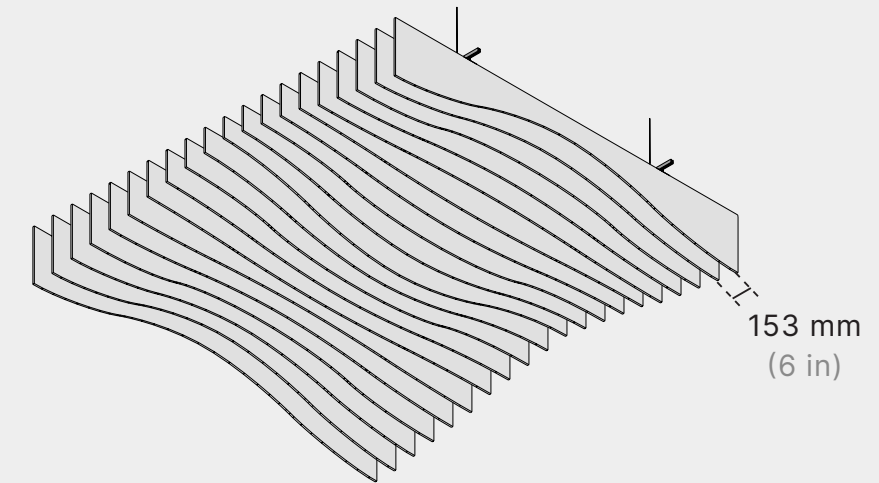

203 mm Spacing (O.C.)

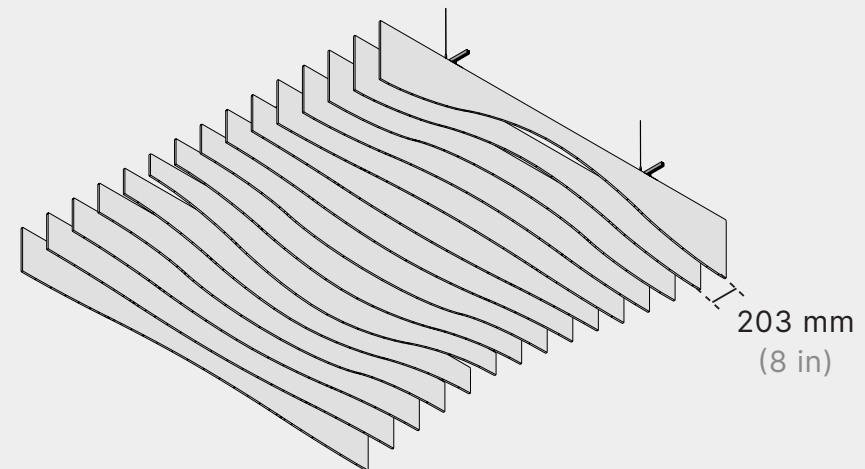

305 mm Spacing (O.C.)

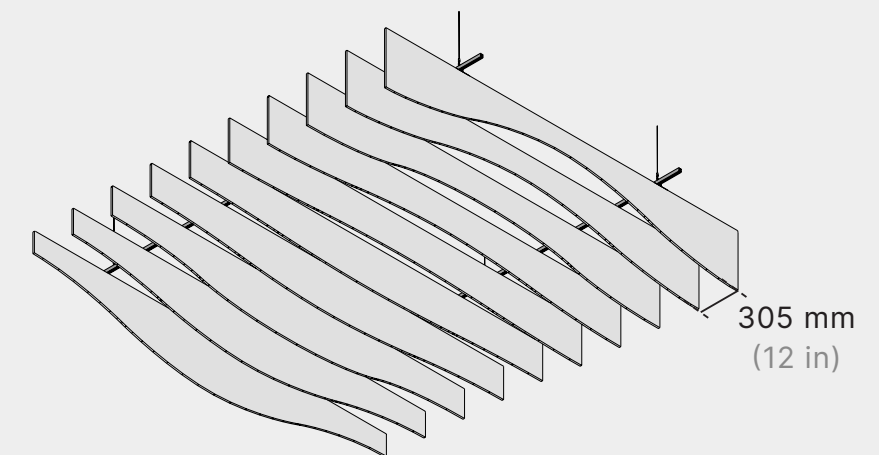

Customization

Custom spacing available.

Standard Colours

Choose from any one of our standard colours.



Pure White
SP 07



Urban Grey
SP 79

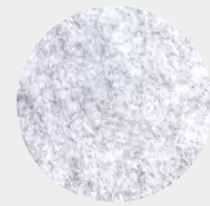

Pumice
SP 11



Warm Grey
SP 76

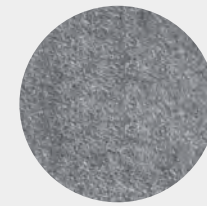

Cool Grey
SP 36

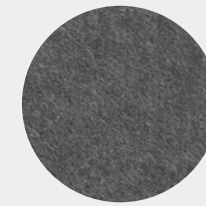

Mid Grey
SP 37

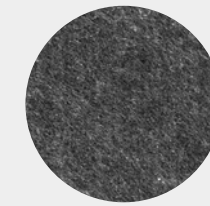

Graphite
SP 03

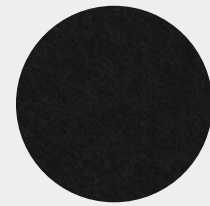

Black
SP 13



Ivory
SP 77



Beige
SP 04



Sandstone
SP 12



Taupe Grey*
SP 90



Castlerock*
SP 80

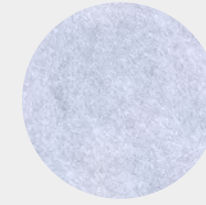

Krypton
SP 30

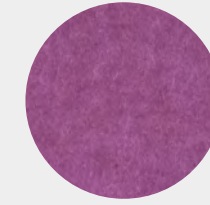

Purple
SP 50

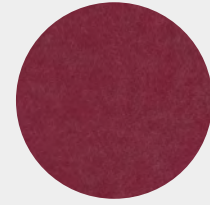

Plum
SP 72

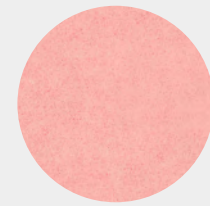

Blush Pink
SP 81

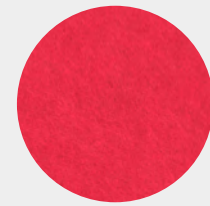

Red
SP 08

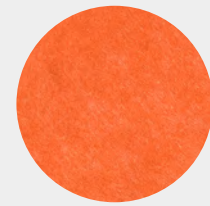

Orange
SP 46

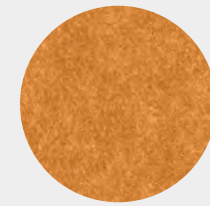

Yam
SP 28

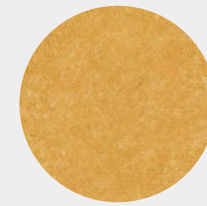

Mustard*
SP 87

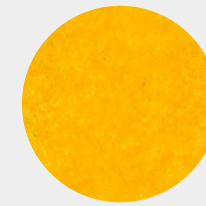

Sunflower
SP 05

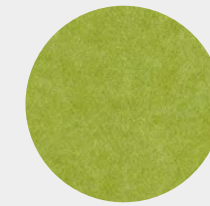

Chartreuse
SP 43

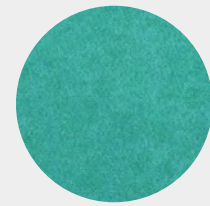

Aquamarine
SP 73

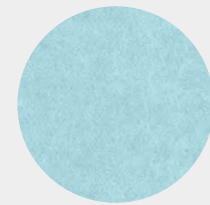

Pale Teal
SP 74

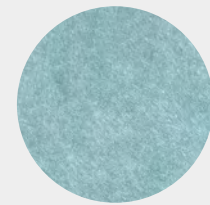

Lagoon*
SP 84

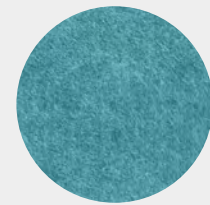

Dark Turquoise
SP 71

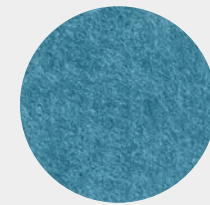

Azure*
SP 85

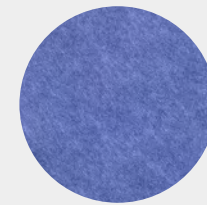

Sky Blue
SP 25



Navy
SP 01

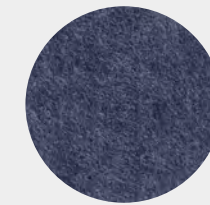

Deep Sea Blue*
SP 83

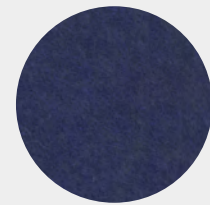

Midnight Blue
SP 19

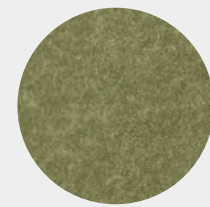

Olive*
SP 88

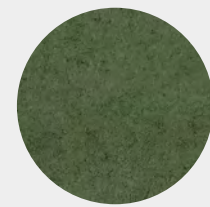

Moss*
SP 89

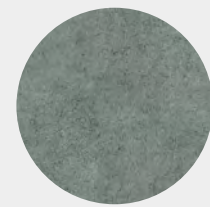

Desert Sage
SP 78

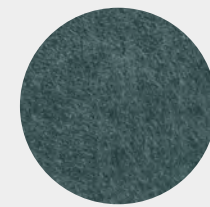

Peacock*
SP 82

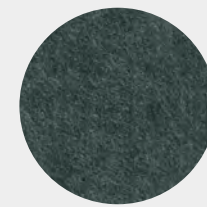

Ocean Green*
SP 86



Forest Green
SP 17

BILLOW

BAFFLES

AKUSTUS.COM

Don't see something you love? Ask us about creating your own custom colour.

All colours available in 9, 12, 18, and 24 mm unless noted otherwise.

* 12 mm / 24 mm only

Installation Option 01

Baffle Cloud Suspension Kit

Baffles are attached to channels and suspended in an array.

- Reduces the number of hanging points on the ceiling
- Hanging points can be moved along the channels

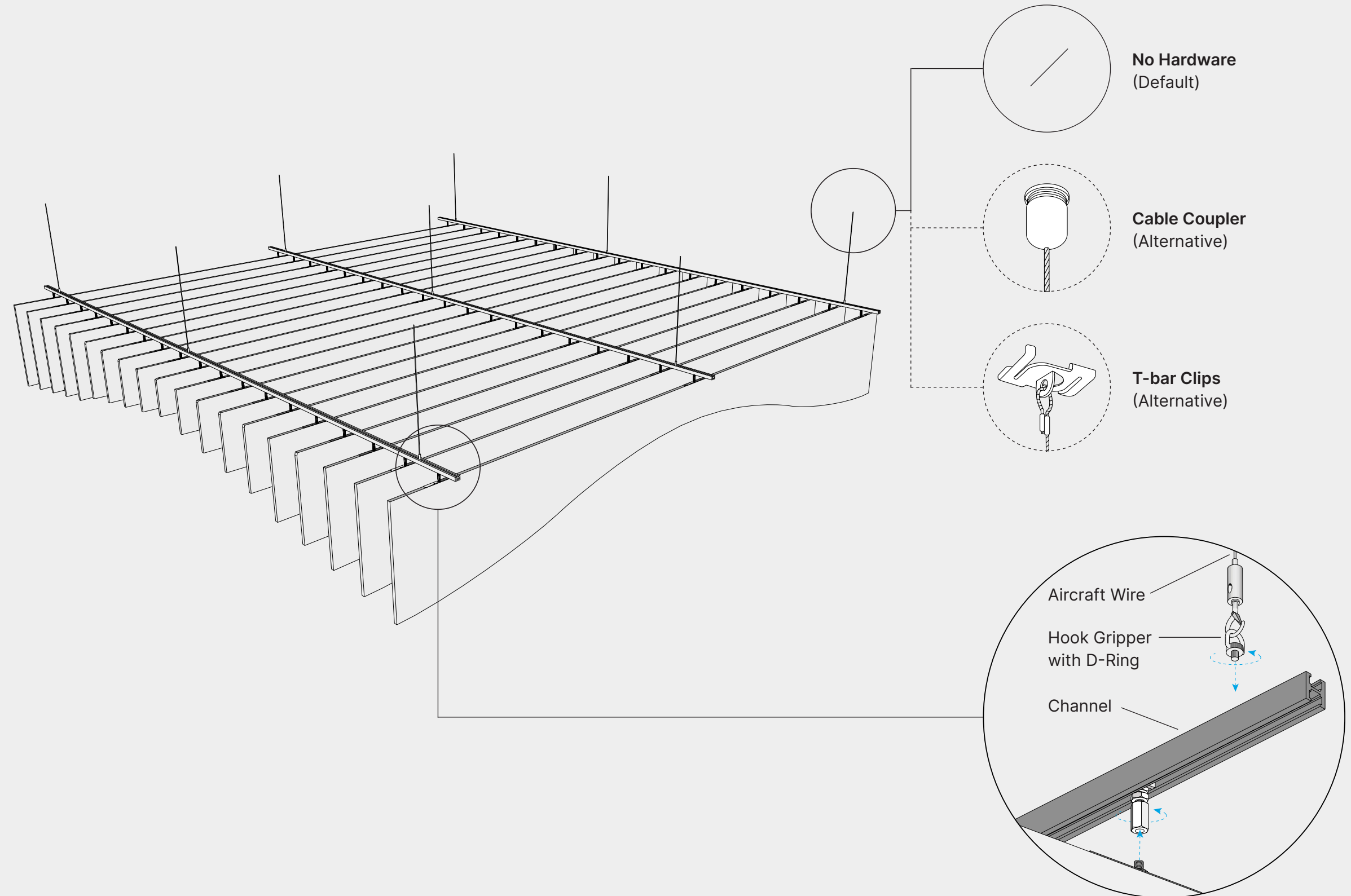

Installation Option 02

Individual Baffle Suspension Kit

Each baffle is suspended by its own set of aircraft wires.

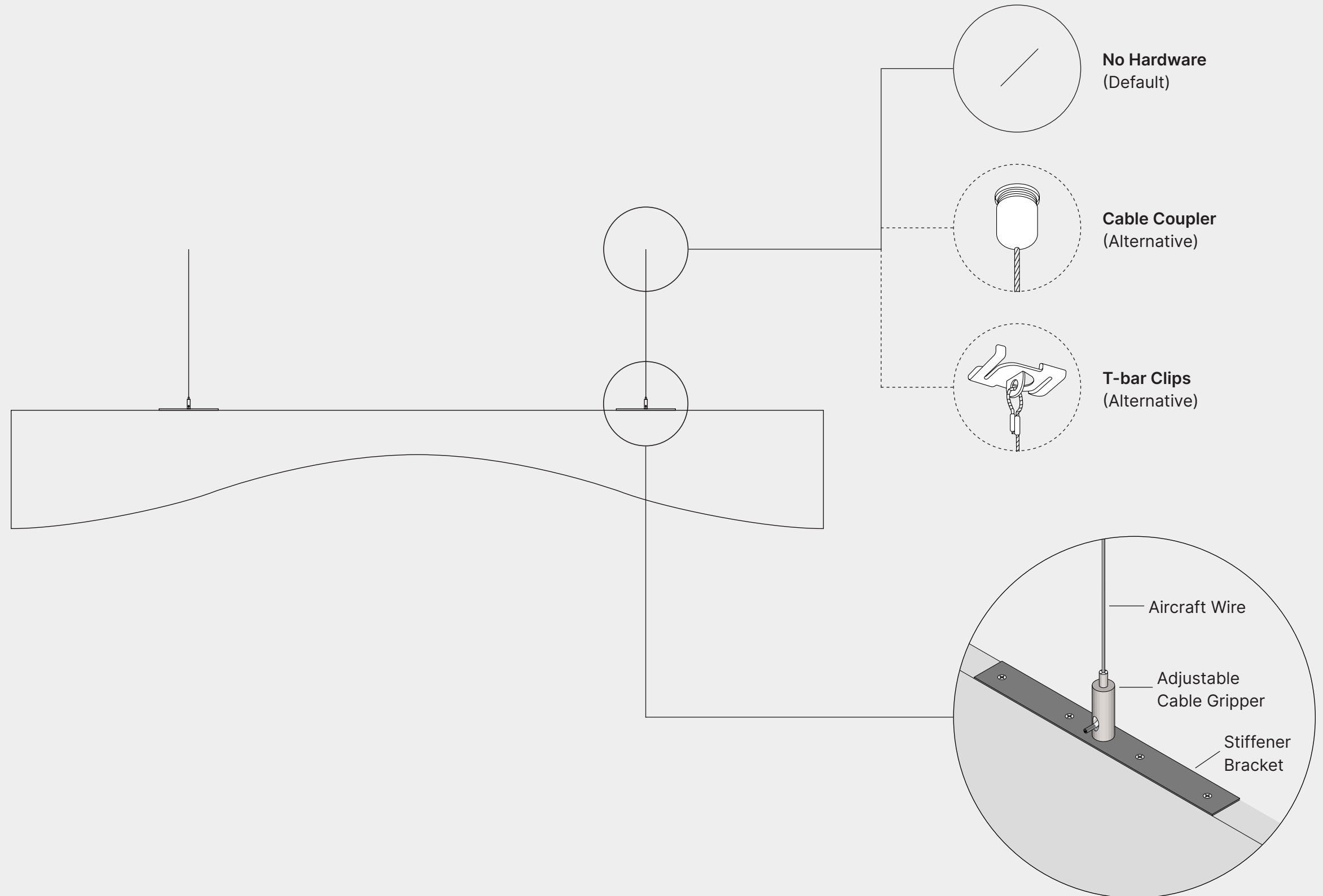

Product Specifications

Billow Baffles

Composition

100% polyester fibre

VOC Emissions

CDPH (CA 01350)

Antimicrobial Testing

Mould & mildew resistant

Fire Rating

- ASTM E84 Class A
- CAN/ULC-S102.2-10

Sustainability

- 100% recyclable
- LBC Red List free
- Contributes to LEED certification
- Free of toxic substances and of off-gassing
- Made with ~60% recycled content from plastic water bottles

Colour & Texture Variations

The felting and dyeing process that forms the material contributes to its unique texture but also to variations in texture and colour from panel to panel. Products will be provided within an acceptable range of variation.



Sound Absorption Graph

The following values reflect the acoustic properties of the product as tested in accordance with ASTM C423-09a.

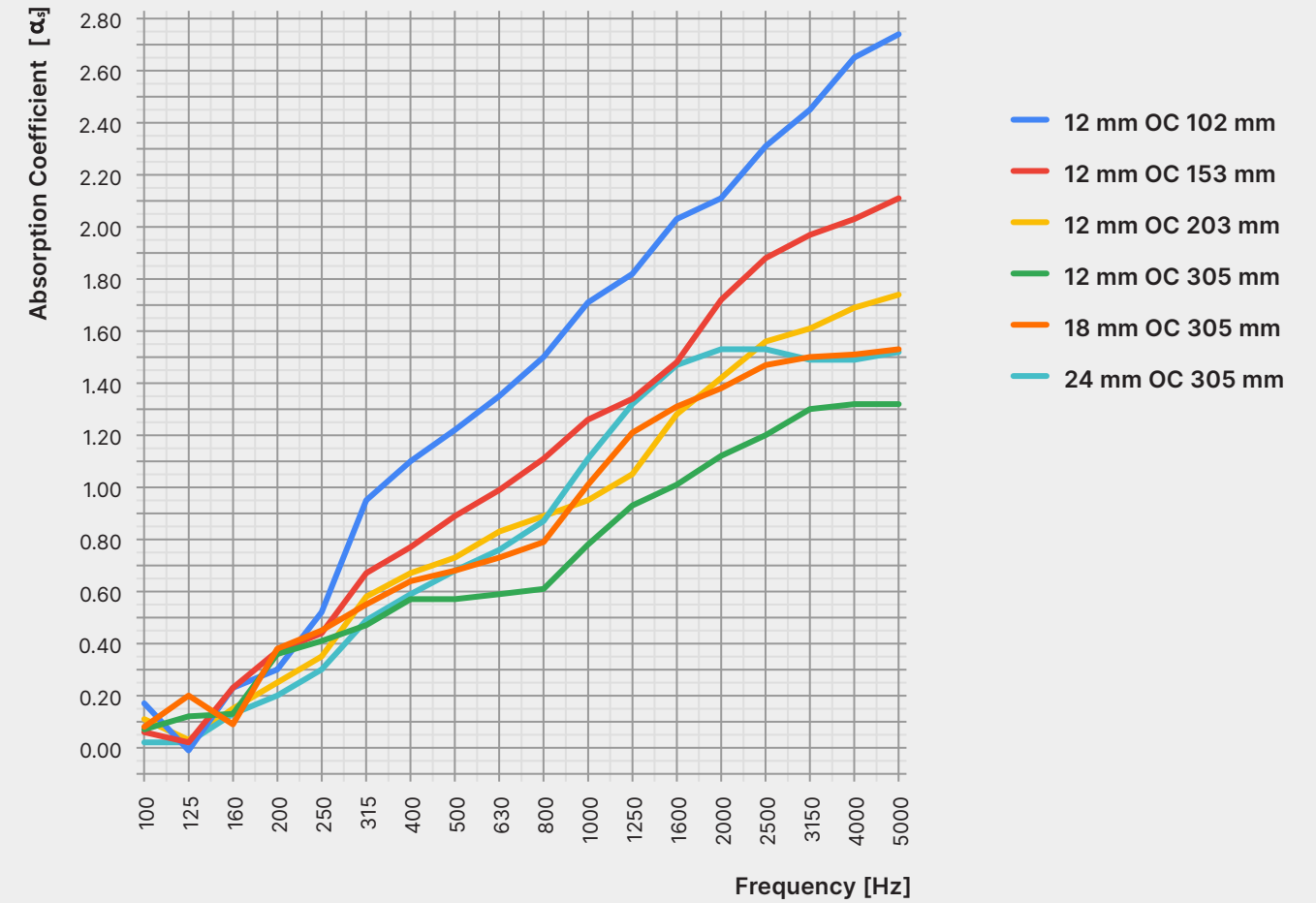

	200	250	315	400	500	630	800	1000	1250	1600	2000	2500	NRC	SAA
12 mm OC 102 mm	0.30	0.52	0.95	1.10	1.22	1.35	1.50	1.71	1.82	2.03	2.11	2.31	1.40	1.41
12 mm OC 153 mm	0.37	0.44	0.67	0.77	0.89	0.99	1.11	1.26	1.34	1.48	1.72	1.88	1.10	1.08
12 mm OC 203 mm	0.25	0.35	0.58	0.67	0.73	0.83	0.89	0.95	1.05	1.28	1.42	1.56	0.85	0.88
12 mm OC 305 mm	0.36	0.41	0.47	0.57	0.57	0.59	0.61	0.78	0.93	1.01	1.12	1.20	0.70	0.72
18 mm OC 305 mm	0.38	0.45	0.55	0.64	0.68	0.73	0.79	1.01	1.21	1.31	1.38	1.47	0.90	0.88
24 mm OC 305 mm	0.20	0.30	0.49	0.59	0.68	0.76	0.87	1.11	1.32	1.47	1.53	1.53	0.90	0.90

Product Care

Handling & Storage

Handle products with care so as to avoid folding the polyester felt, chipping its edges, or indenting its faces. Store products in their original containers in a well-ventilated area until the intended application environment is ready for installation. Allow products to acclimatize to environmental conditions. Lay them flat on their faces; do not stand them on their edges. Protect from moisture, heat, direct sunlight, and the elements.

Warranty

AKUSTUS warrants the construction and finish of all our products to be free from defects in material and workmanship for a period of 1 year from the date of purchase.

