

# Cargo LED Baffles





Our classic baffle now brightens up your space along with dampening noise in modest fashion. Include Cargo LED in a cloud of Cargo Baffles to tackle the trickiest of lighting and acoustic settings.

# How to Specify

Step by step instructions on how to specify Cargo LED Baffles.

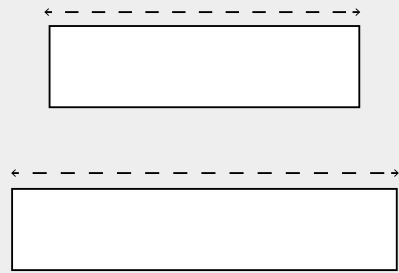

**01**  
**Choose baffle length.**  
(pg 03)

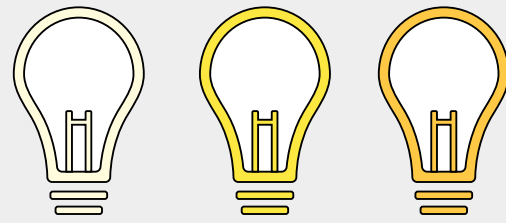

**02**  
**Choose lighting colour temperature.**  
(pg 04)

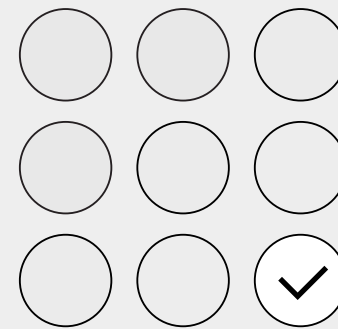

**03**  
**Choose baffle colour.**  
(pg 05-06)

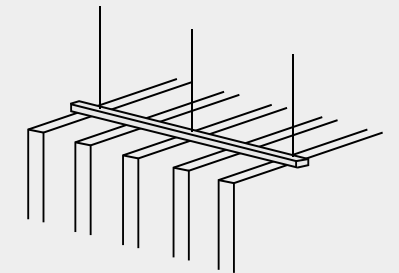

**04**  
**Choose installation method.**  
(pg 07)

# Dimensions

---

## Standard Dimensions (mm)

610 L (min.) x 305 H

2440 L (max.) x 305 H

(Size variations come in 305 mm increments due to LED lengths)

---

## Standard Thicknesses (mm)

60, 75

---

## Edge Detail



Box Edge

---

## Customization

Length and Height can be customized to fit your space.

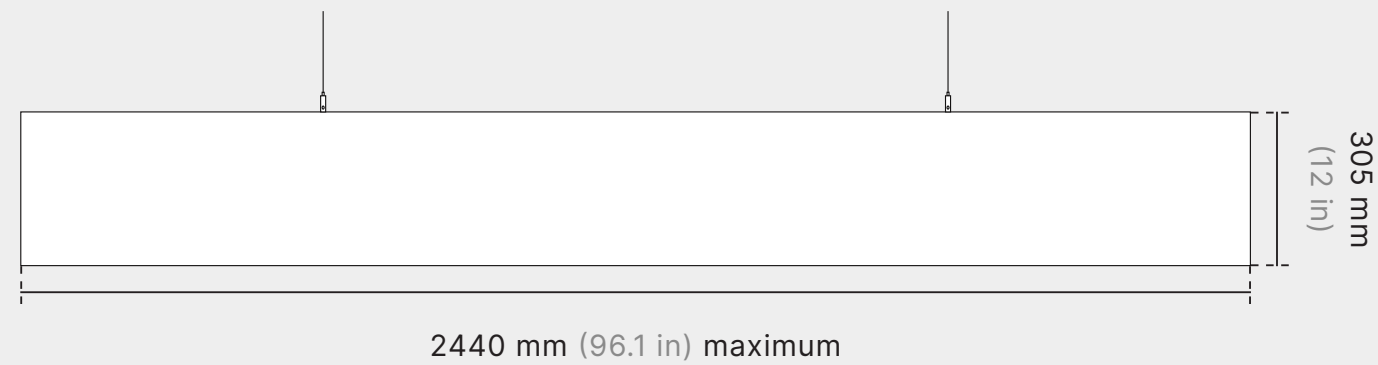
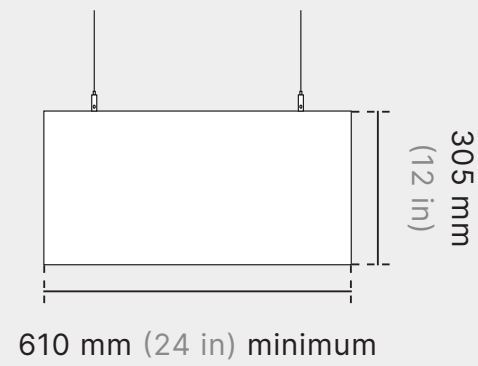

# Luminaire Specifications

## Design A

### Voltage

Universal 120-277 VAC

### Direct Lumen Output

550 lm/ft, 850 lm/ft

### Colour Rendering Index (CRI)

80+

### Correlated Colour Temperature (CCT)

3000 K, 3500 K, 4000 K

### Nominal Length

2 ft, 3 ft, 4 ft, 5 ft, 6 ft, 7 ft, 8 ft

### Dimming

TRIAC, 0-10 V

### Safety

UL 1598 approved

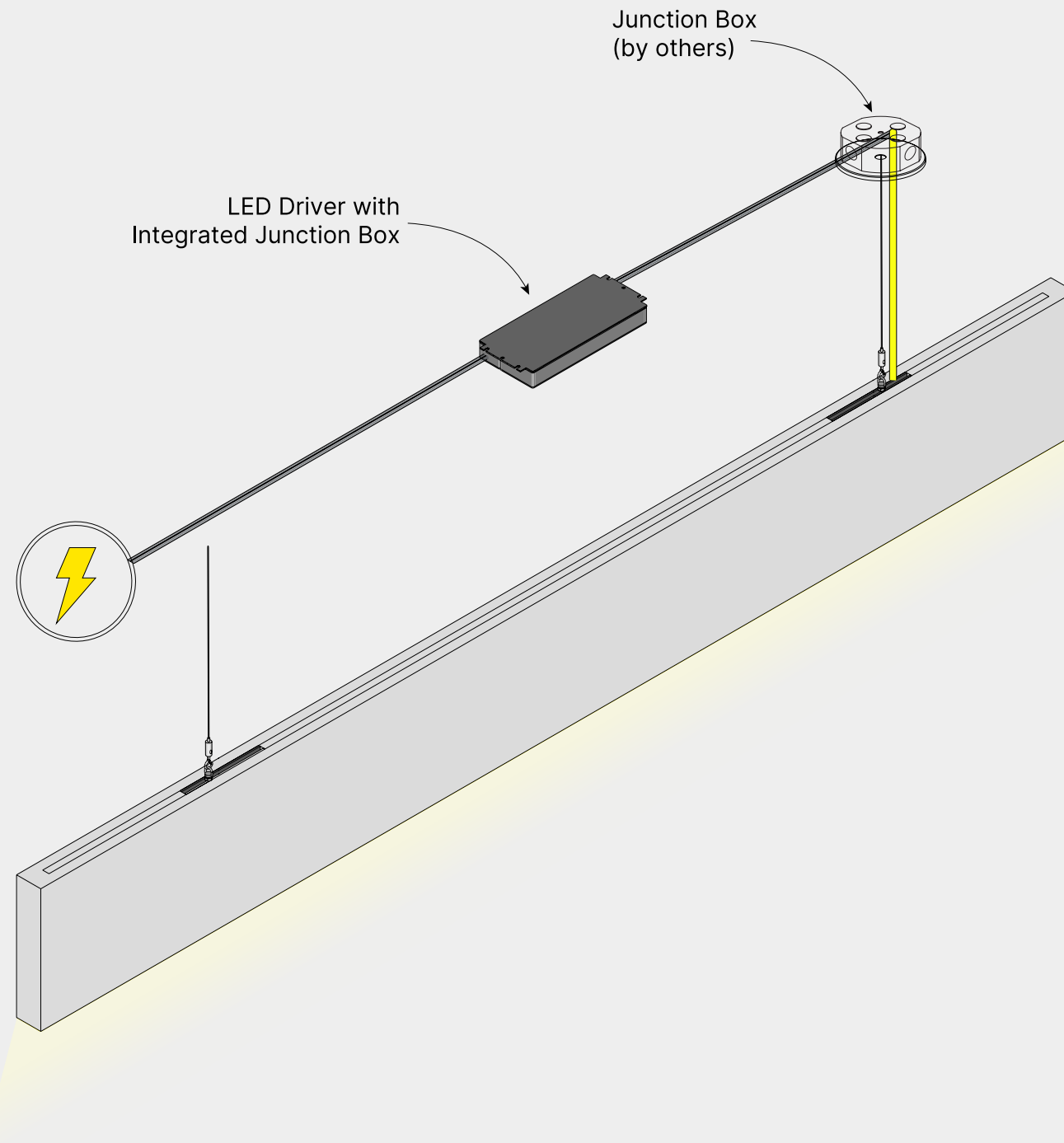

# Standard Colours

Choose from any one of our standard colours.



**Pure White**  
SP 07



**Urban Grey**  
SP 79

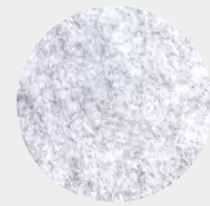

**Pumice**  
SP 11

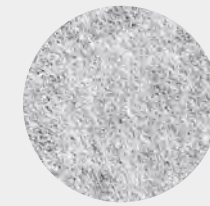

**Warm Grey**  
SP 76

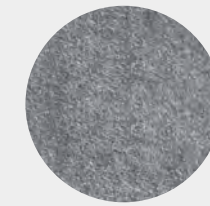

**Cool Grey**  
SP 36

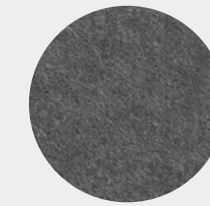

**Mid Grey**  
SP 37

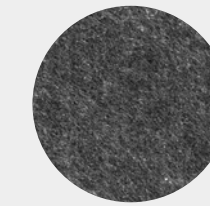

**Graphite**  
SP 03

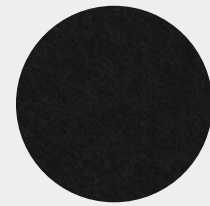

**Black**  
SP 13



**Ivory**  
SP 77



**Beige**  
SP 04



**Sandstone**  
SP 12



**Taupe Grey\***  
SP 90

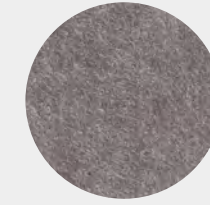

**Castlerock\***  
SP 80

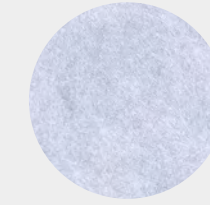

**Krypton**  
SP 30



**Purple**  
SP 50

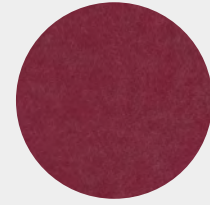

**Plum**  
SP 72

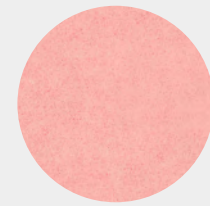

**Blush Pink**  
SP 81

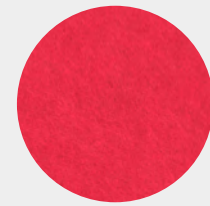

**Red**  
SP 08

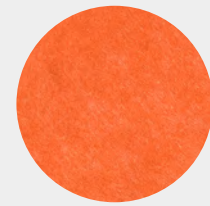

**Orange**  
SP 46

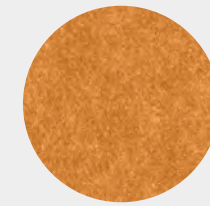

**Yam**  
SP 28

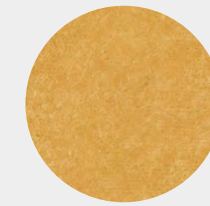

**Mustard\***  
SP 87

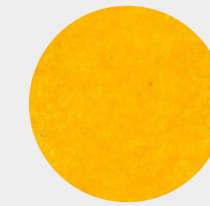

**Sunflower**  
SP 05

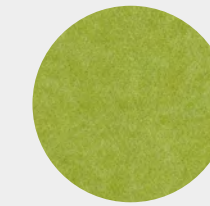

**Chartreuse**  
SP 43

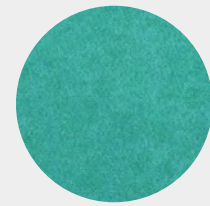

**Aquamarine**  
SP 73

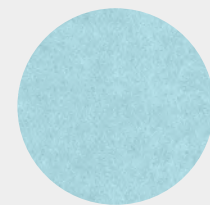

**Pale Teal**  
SP 74

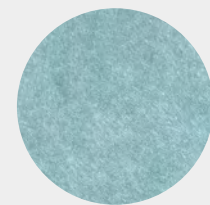

**Lagoon\***  
SP 84

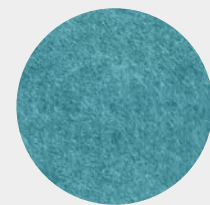

**Dark Turquoise**  
SP 71

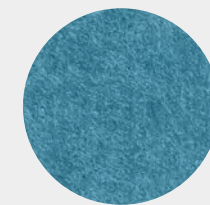

**Azure\***  
SP 85

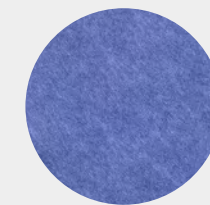

**Sky Blue**  
SP 25

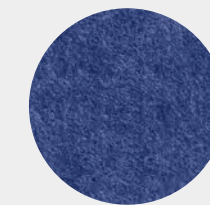

**Navy**  
SP 01



**Deep Sea Blue\***  
SP 83



**Midnight Blue**  
SP 19

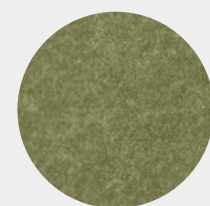

**Olive\***  
SP 88

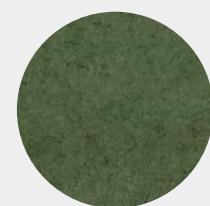

**Moss\***  
SP 89



**Desert Sage**  
SP 78

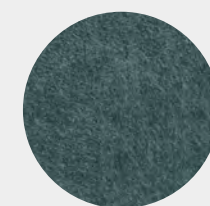

**Peacock\***  
SP 82

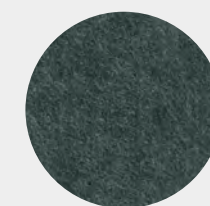

**Ocean Green\***  
SP 86



**Forest Green**  
SP 17

CARGO LED

BAFFLES

AKUSTUS.COM

Don't see something you love? Ask us about creating your own custom colour.

All colours available in 9, 12, 18, and 24 mm unless noted otherwise.

\* 12 mm / 24 mm only

# Textures

Create a natural look and feel with printed textures.



White Oak



Silver Oak



Greige Oak



Ebony Oak

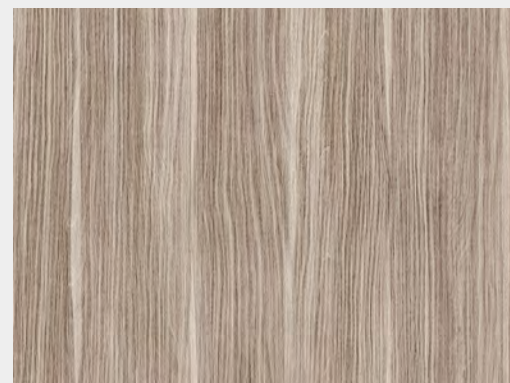

Cafe Oak

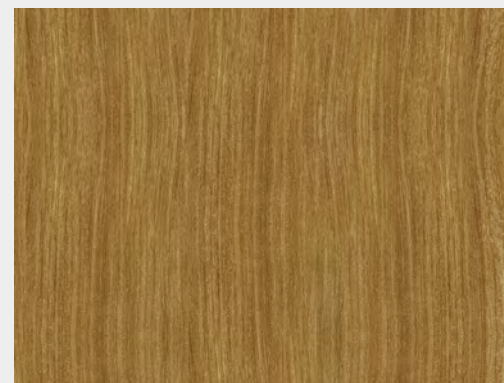

Golden Oak

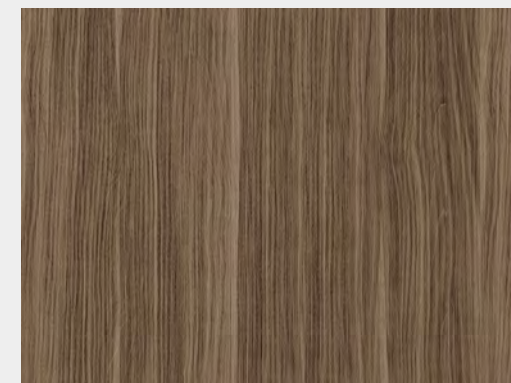

Teak

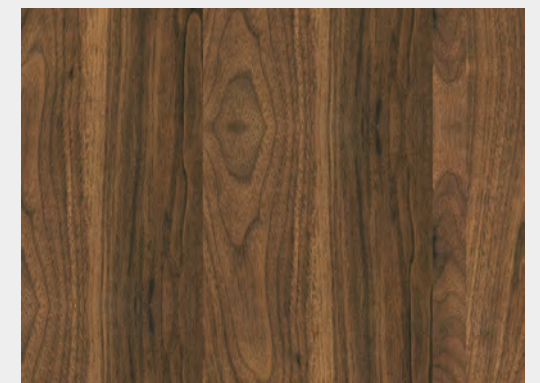

Walnut

---

Have something you want to print? Talk to us about printing a custom texture, design or image.

# Installation

## Individual Baffle Suspension Kit

Each baffle is suspended by its own set of aircraft wires.

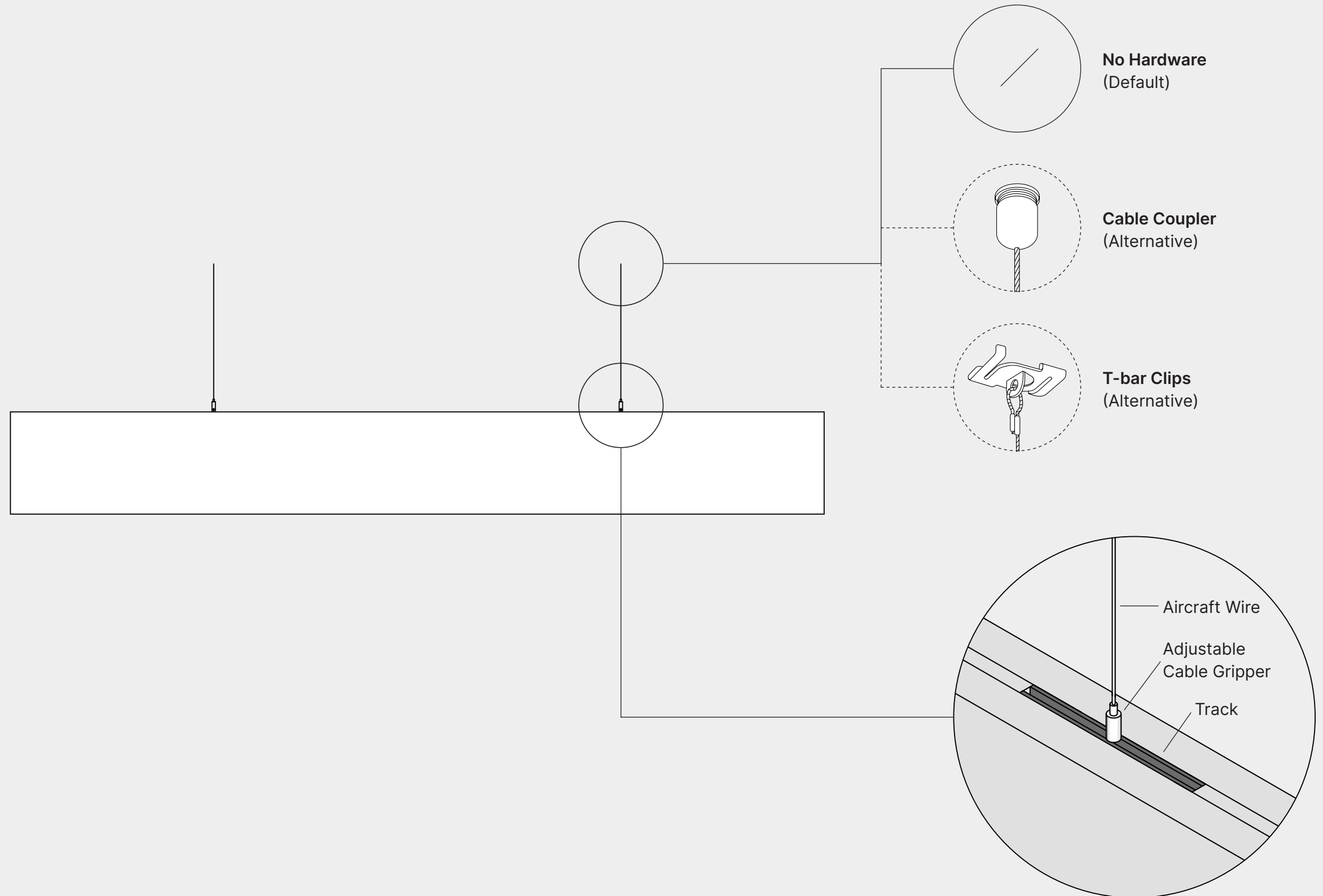



# Product Specifications

## Cargo LED Baffles

### Composition

100% polyester fibre

### VOC Emissions

CDPH (CA 01350)

### Antimicrobial Testing

Mould & mildew resistant

### Fire Rating

- ASTM E84 Class A
- CAN/ULC-S102.2-10

**Declare.**

### Sustainability

- 100% recyclable
- LBC Red List free
- Contributes to LEED certification
- Free of toxic substances and of off-gassing
- Made with ~60% recycled content from plastic water bottles

### Colour & Texture Variations

The felting and dyeing process that forms the material contributes to its unique texture but also to variations in texture and colour from panel to panel. Products will be provided within an acceptable range of variation.

# Sound Absorption Graph

The following values reflect the acoustic properties of the product as tested in accordance with ASTM C423-09a.

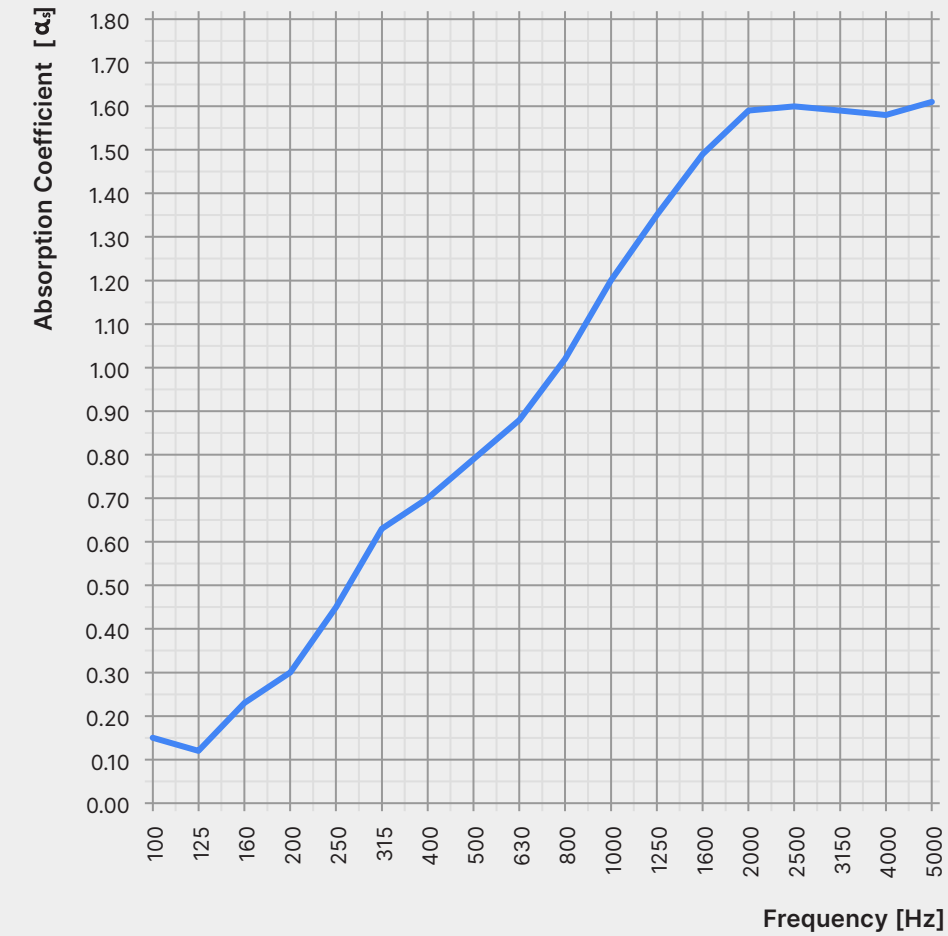

200	250	315	400	500	630	800	1000	1250	1600	2000	2500	NRC	SAA
0.30	0.45	0.63	0.70	0.79	0.88	1.02	1.20	1.35	1.49	1.59	1.60	1.00	1.00

# Product Care

## Handling & Storage

Handle products with care so as to avoid folding the polyester felt, chipping its edges, or indenting its faces. Store products in their original containers in a well-ventilated area until the intended application environment is ready for installation. Allow products to acclimatize to environmental conditions. Lay them flat on their faces; do not stand them on their edges. Protect from moisture, heat, direct sunlight, and the elements.

## Warranty

AKUSTUS warrants the construction and finish of all our products to be free from defects in material and workmanship for a period of 1 year from the date of purchase.



## Maintenance

Lightly brush or gently vacuum to remove dust from polyester felt. Clean with warm water and mild, non-toxic soap to remove spills. Test solution on an inconspicuous spot before applying to more visible areas. Blot with a dry cloth after applying the solution to avoid saturating the material. Avoid applying too much pressure when cleaning the products.

CARGO LED

BAFFLES

AKUSTUS.COM

