

Carton Baffles





Whatever their orientation or arrangement, Carton Baffle's lines lead to more peaceful soundscapes and more stunning environments. The system's aluminum frame comes equipped with baffle hooks so that installing the baffles is as easy as just pushing them onto the frame. With Carton Baffles covering the ceiling, you can elevate the atmosphere of any room.

How to Specify

Step by step instructions on how to specify Carton Baffles.

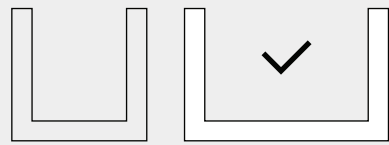

01

Choose baffle dimensions.

(pg 03)

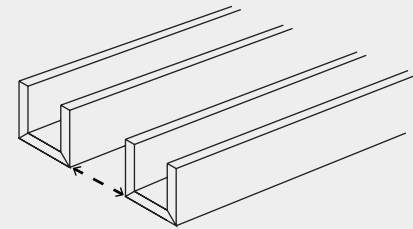

02

Choose baffle spacing.

(pg 04)

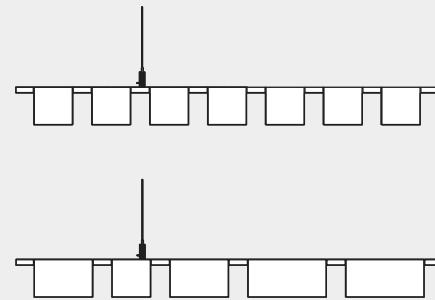

03

Choose configuration or create your own.

(pg 04)

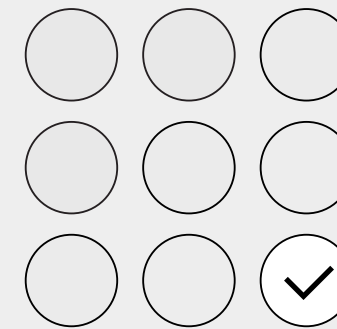

04

Choose colour or texture.

(pg 05-06)

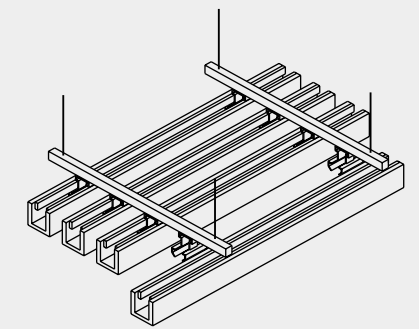

05

Choose installation method.

(pg 07)

Dimensions

Carton Baffle comes in 3 standard sizes.

Design A

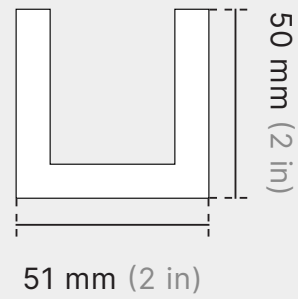

Design B

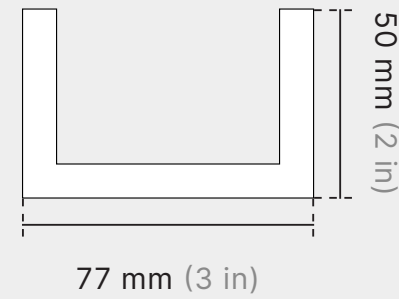

Design C



Standard Dimensions (mm)

- A 51 W x 50 H
- B 77 W x 50 H
- C 103 W x 50 H

Edge Detail



Box Edge

Customization

Length and Height can be customized to fit your space.

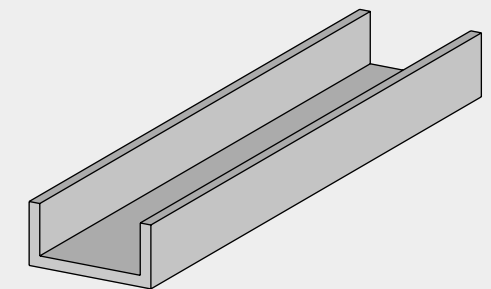
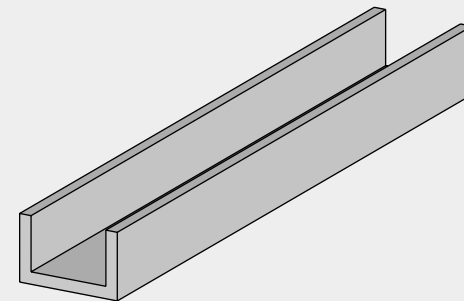
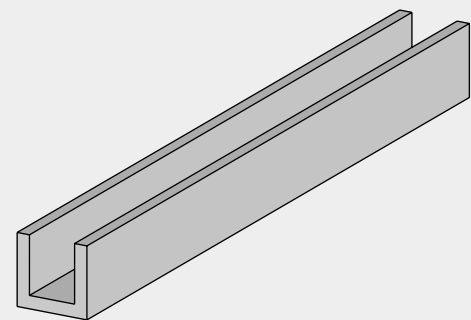

Configurations

Vary baffle sizes and spacing to create a dynamic look.

Standard

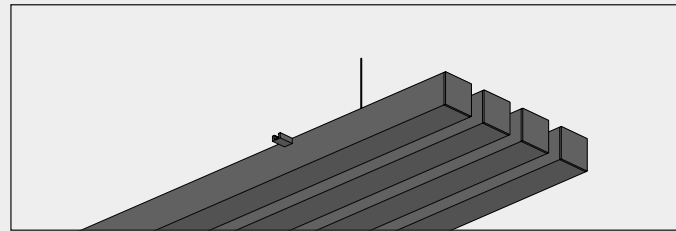

Config 1

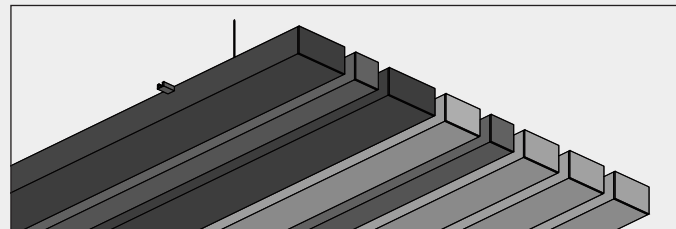
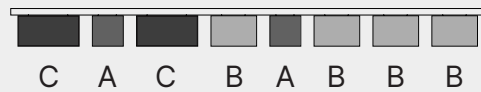

Config 2

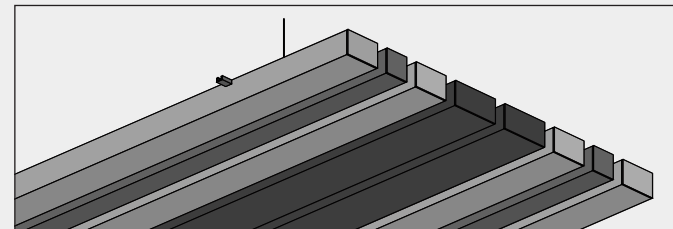
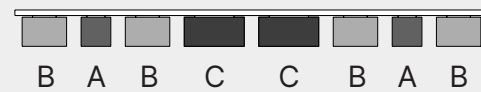

Config 3

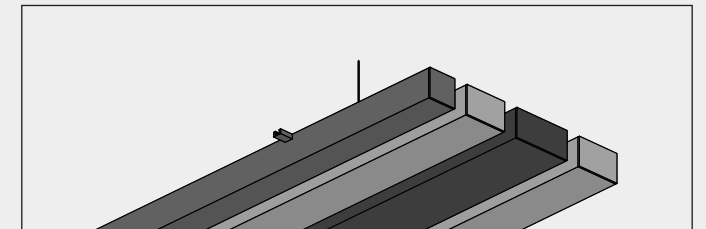
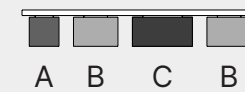

Standard Spacing Options

25 mm

50 mm

Spacing measured from edge to edge. Custom spacing available.

Standard Colours

Choose from any one of our standard colours.



Pure White
SP 07



Urban Grey
SP 79



Pumice
SP 11



Warm Grey
SP 76

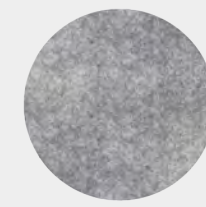

Cool Grey
SP 36

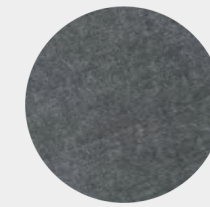

Mid Grey
SP 37

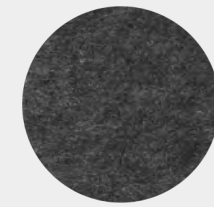

Graphite
SP 03



Black
SP 13



Ivory
SP 77



Beige
SP 04



Sandstone
SP 12



Taupe Grey*
SP 90

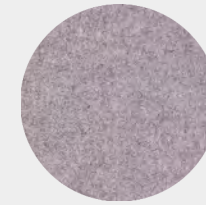

Castlerock*
SP 80

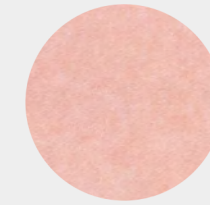

Blush Pink
SP 81



Plum
SP 72



Red
SP 08

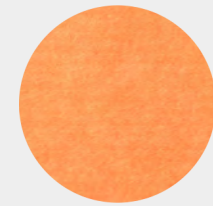

Orange
SP 46

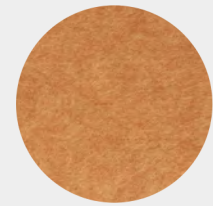

Yam
SP 28

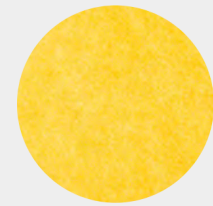

Sunflower
SP 05

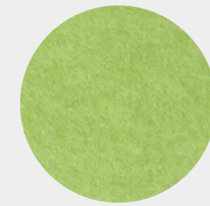

Chartreuse
SP 43

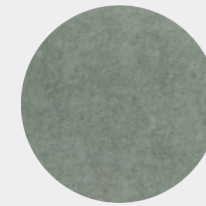

Desert Sage
SP 78

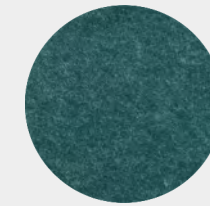

Peacock*
SP 82



Mustard*
SP 87



Olive*
SP 88



Moss*
SP 89



Lagoon*
SP 84



Azure*
SP 85



Forest Green
SP 17



Ocean Green*
SP 86



Deep Sea Blue*
SP 83



Krypton
SP 30



Pale Teal
SP 74

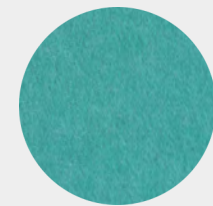

Aquamarine
SP 73

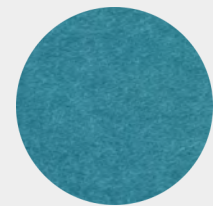

Dark Turquoise
SP 71

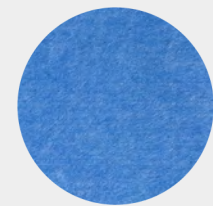

Sky Blue
SP 25

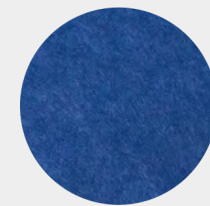

Navy
SP 01

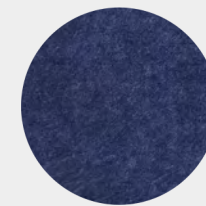

Midnight Blue
SP 19



Purple
SP 50

Don't see something you love? Ask us about creating your own custom colour.

All colours available in 9, 12, 18, and 24 mm unless noted otherwise.

* 12 mm / 24 mm only

Textures

Create a natural look and feel with printed textures.



White Oak



Silver Oak



Greige Oak



Ebony Oak

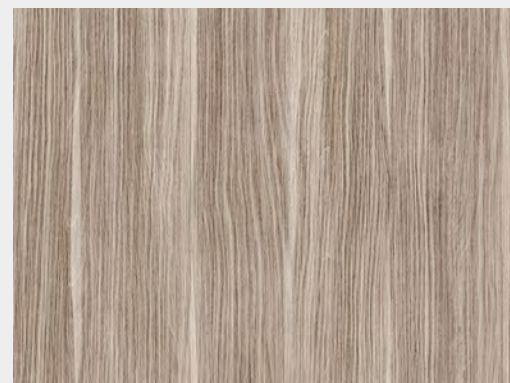

Cafe Oak

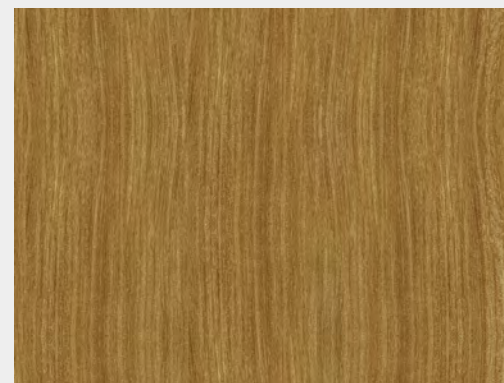

Golden Oak

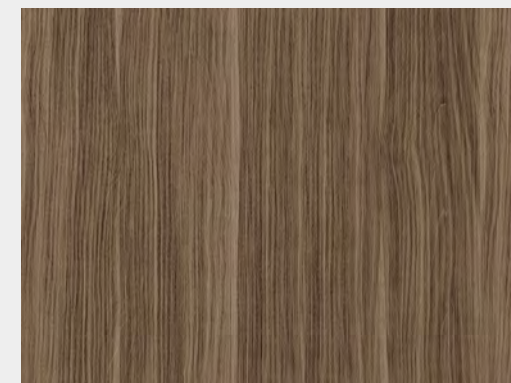

Teak

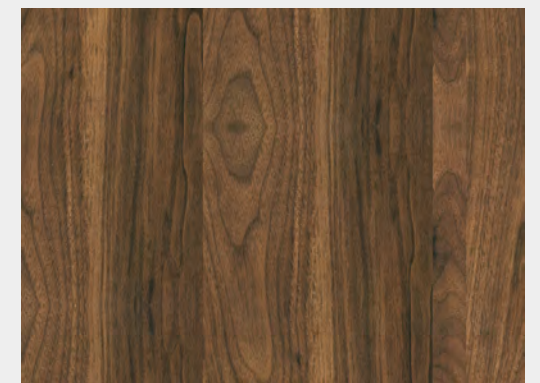

Walnut

Have something you want to print? Talk to us about printing a custom texture, design or image.

Installation

Baffle Hook Suspension Kit

Baffle hooks allow easy installation and removal of baffles.

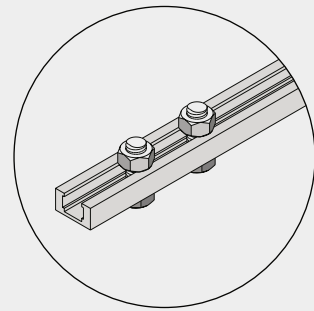

Stabilizer Bar

- Helps maintain cloud shape

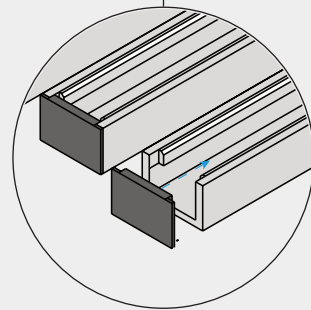
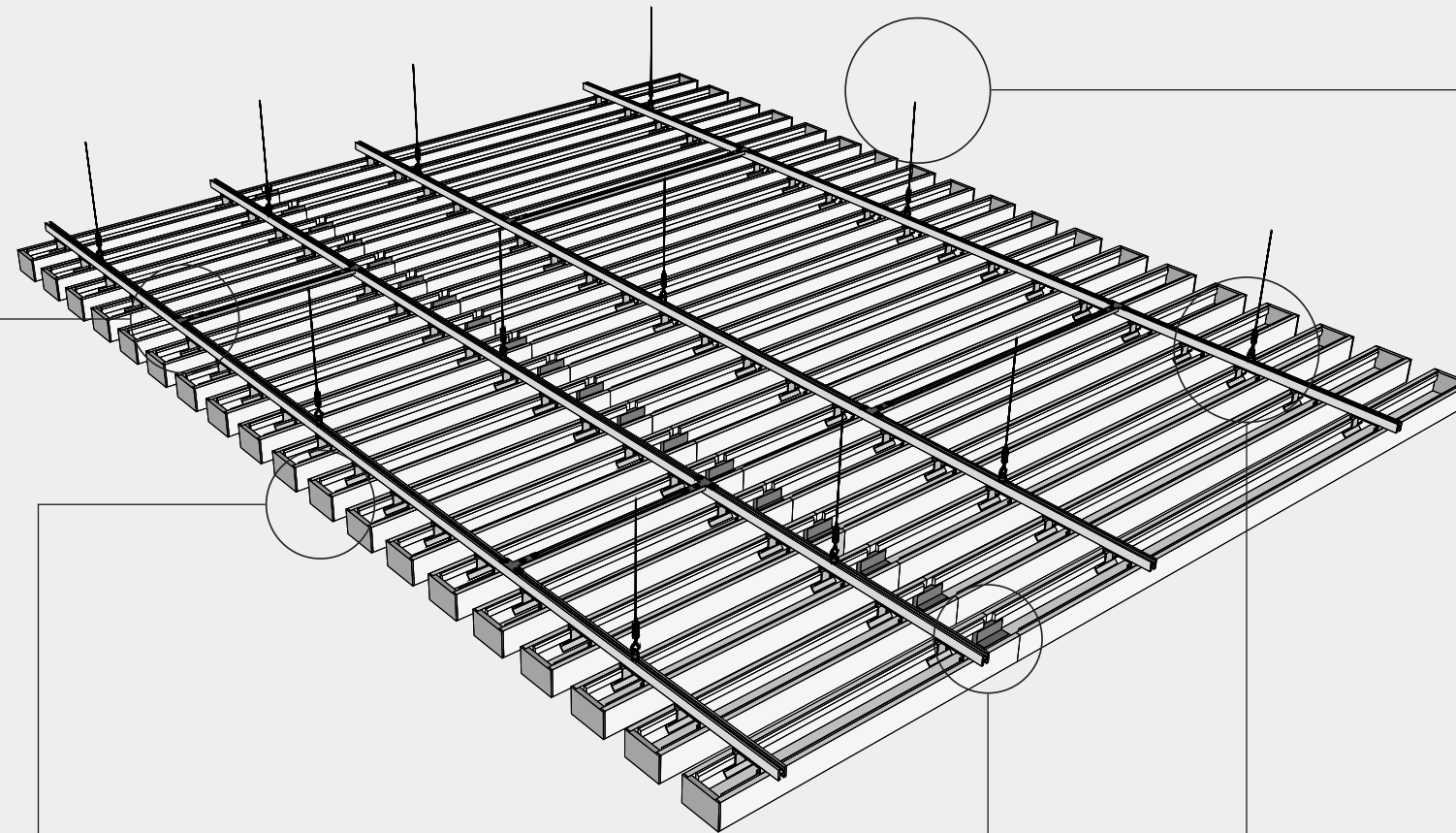

End Caps

- Caps match material colour

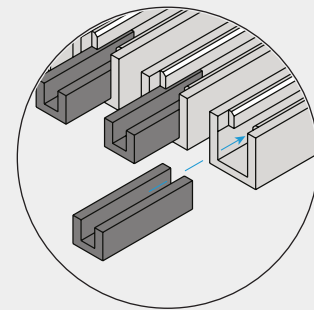

Baffle Splices

- Connect adjacent baffles

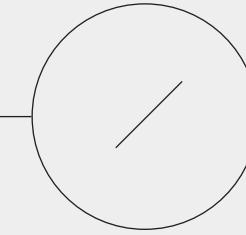

No Hardware (Default)

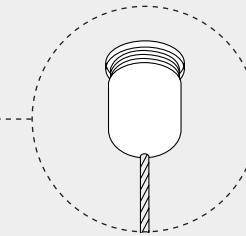

Cable Coupler (Alternative)

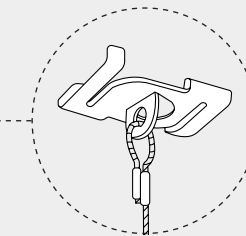

T-bar Clips (Alternative)

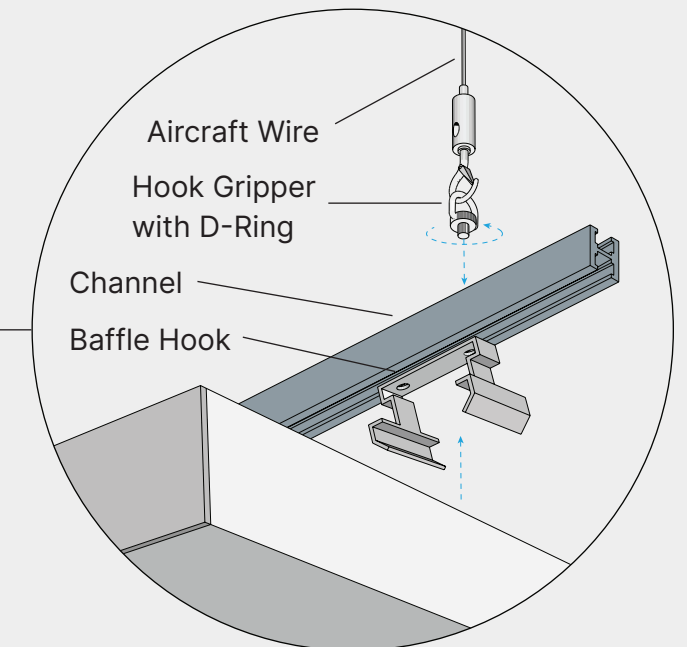

Product Specifications

Carton Baffles

Composition

100% polyester fibre

VOC Emissions

CDPH (CA 01350)

Antimicrobial Testing

Mould & mildew resistant

Fire Rating

- ASTM E84 Class A
- CAN/ULC-S102.2-10

Declare.

Sustainability

- 100% recyclable
- LBC Red List free
- Contributes to LEED certification
- Free of toxic substances and of off-gassing
- Made with ~60% recycled content from plastic water bottles

Colour & Texture Variations

The felting and dyeing process that forms the material contributes to its unique texture but also to variations in texture and colour from panel to panel. Products will be provided within an acceptable range of variation.

Sound Absorption Graph

The following values reflect the acoustic properties of the product as tested in accordance with ASTM C423-09a.

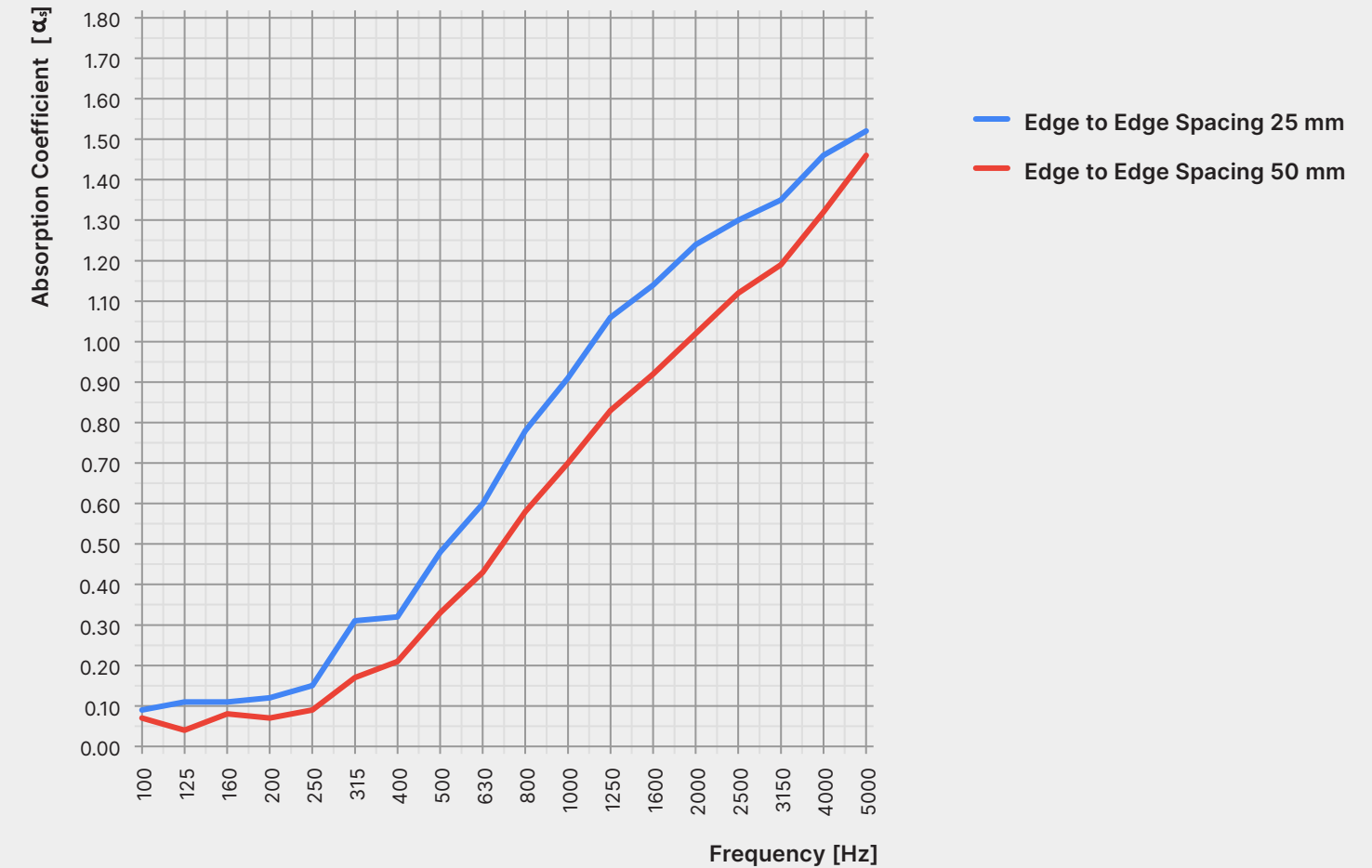

	200	250	315	400	500	630	800	1000	1250	1600	2000	2500	NRC	SAA
Spacing 25 mm	0.12	0.15	0.31	0.32	0.48	0.60	0.78	0.91	1.06	1.14	1.24	1.30	0.70	0.70
Spacing 50 mm	0.07	0.09	0.17	0.21	0.33	0.43	0.58	0.70	0.83	0.92	1.02	1.12	0.55	0.54

Product Care

Handling & Storage

Handle products with care so as to avoid folding the polyester felt, chipping its edges, or indenting its faces. Store products in their original containers in a well-ventilated area until the intended application environment is ready for installation. Allow products to acclimatize to environmental conditions. Lay them flat on their faces; do not stand them on their edges. Protect from moisture, heat, direct sunlight, and the elements.

Warranty

AKUSTUS warrants the construction and finish of all our products to be free from defects in material and workmanship for a period of 1 year from the date of purchase.



Maintenance

Lightly brush or gently vacuum to remove dust from polyester felt. Clean with warm water and mild, non-toxic soap to remove spills. Test solution on an inconspicuous spot before applying to more visible areas. Blot with a dry cloth after applying the solution to avoid saturating the material. Avoid applying too much pressure when cleaning the products.

CARTON

BAFFLES

AKUSTUS.COM

