

# Rectangle Large

PANEL

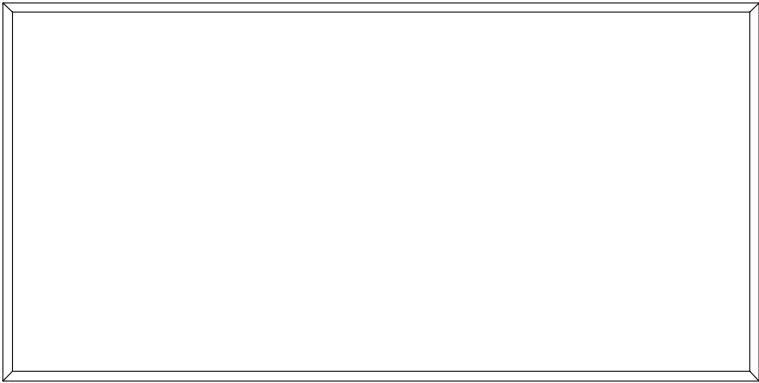

## DESCRIPTION

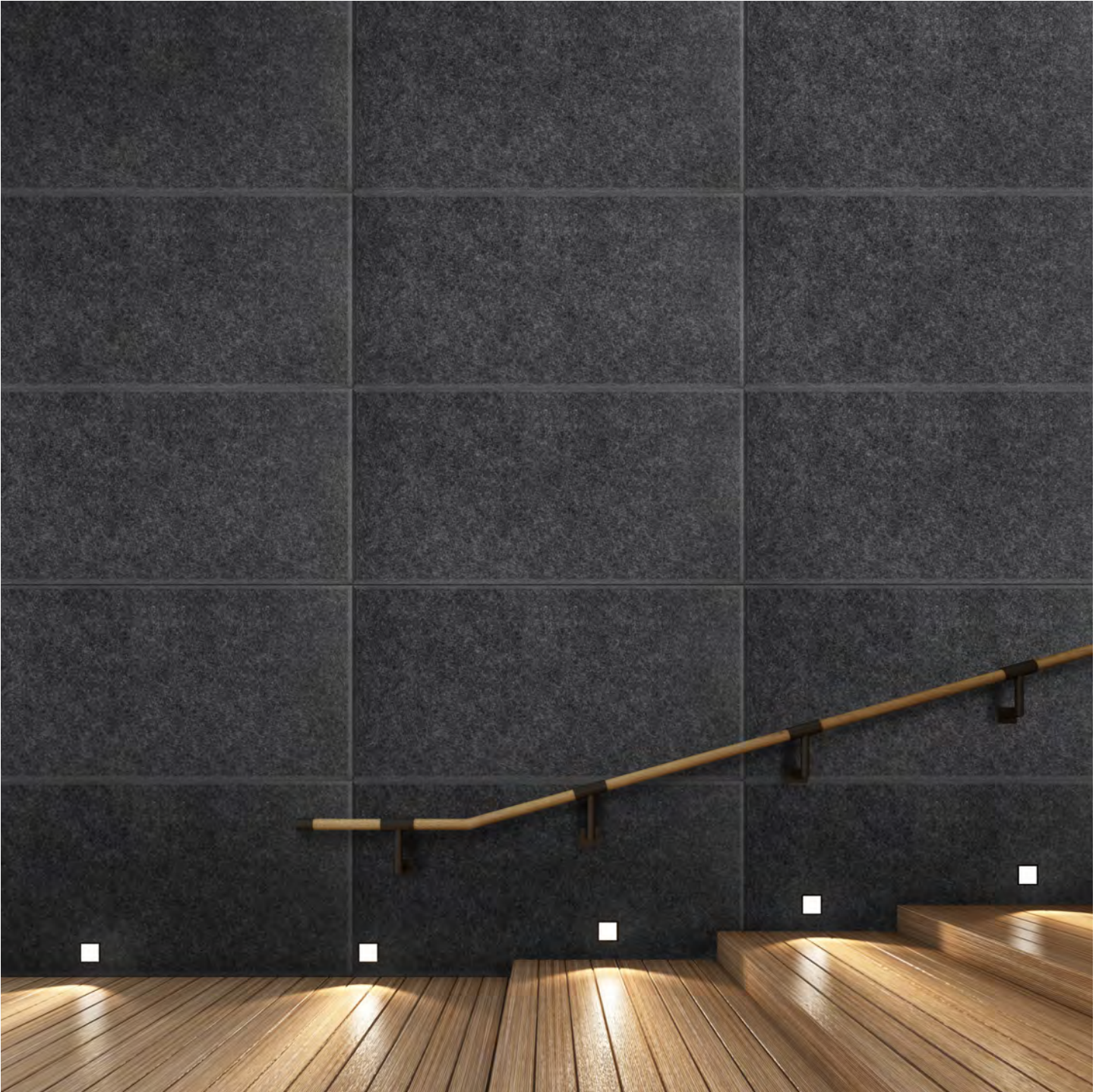

Minimalist and adaptable, the Rectangle panel improves the acoustics and the aesthetics of any space it adorns. The panel can easily be installed on to a variety of surfaces through the use of adhesive.

# DIMENSIONS

FRONT

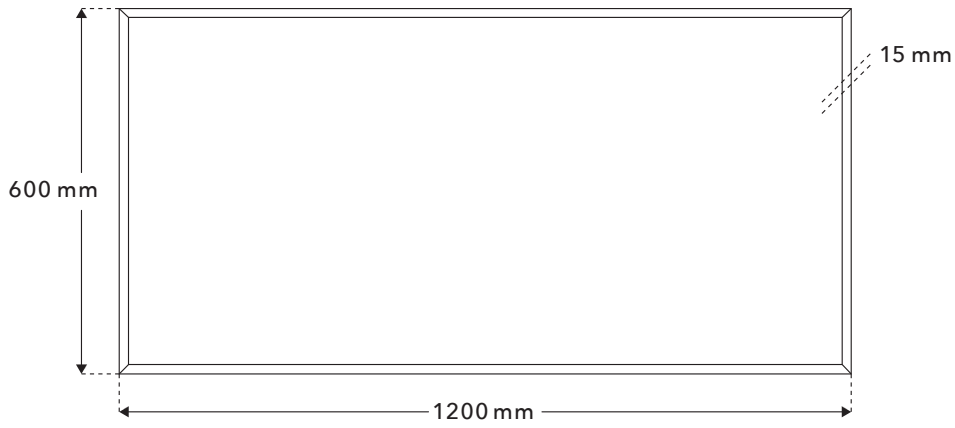

SIDE

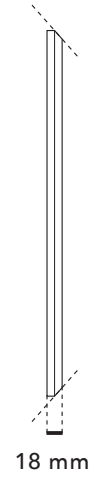

ANGLED

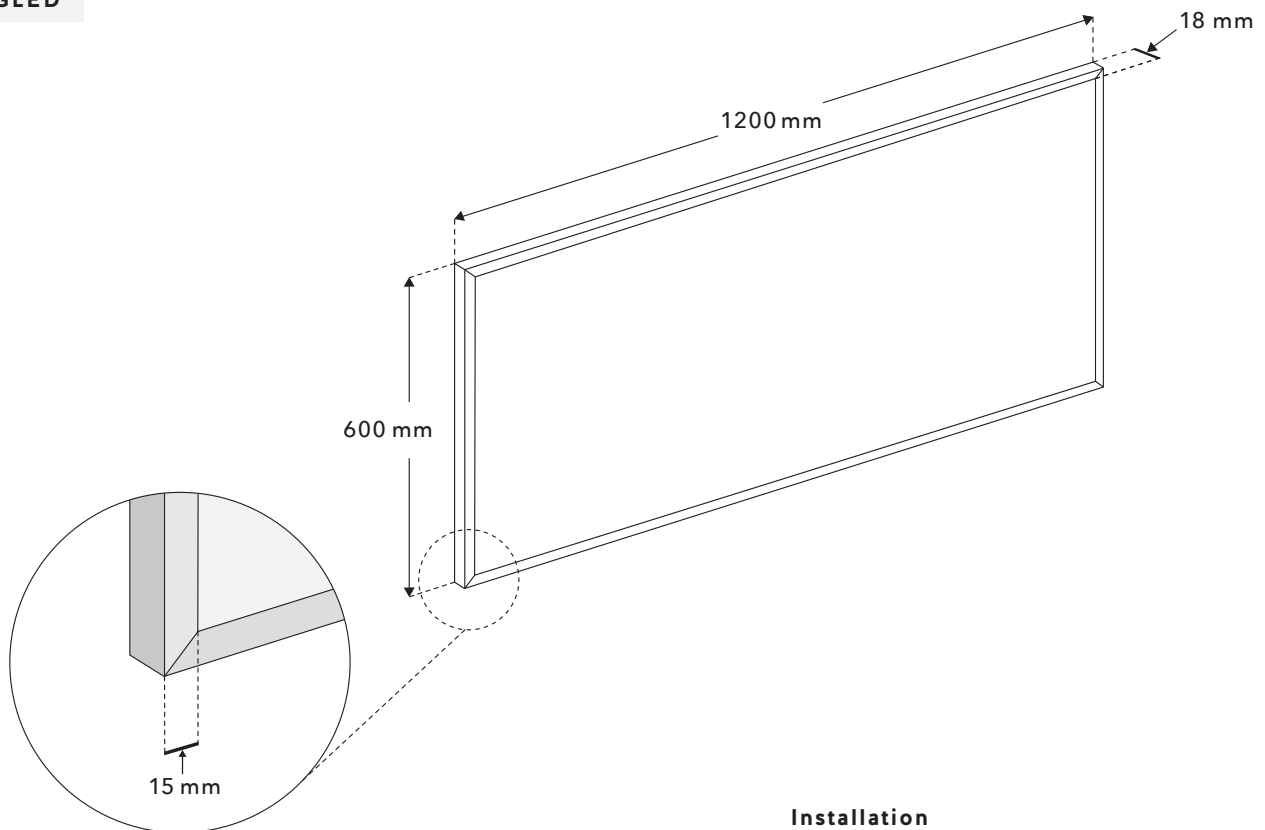

## Installation

For details on how to install this product, please refer to the *Adhesive Installation Guide*.

## SPECIFICATIONS

**PRODUCT NAME** Rectangle Large

**COMPOSITION** 100% polyester fibre

**DIMENSIONS** 1200 mm x 600 mm

**THICKNESS** 18 mm (*alternative thicknesses available on request*)

**MIN. SIZE** 300 mm x 150 mm

**MAX. SIZE** 2400 mm x 1200 mm

**WEIGHT** 6 lbs

**EDGE DETAIL** Bevelled (*straight edge available*)

**ACOUSTIC PROPERTIES** ASTM C423 (NRC): 0.60

**FIRE RATING** CAN/ULC S102.2-10

**ENVIRONMENTAL** AKUSTUS panels are made from approximately 50% recycled content originating from recycled water bottles. The panels are 100% recyclable, free of toxic substances and free of off-gassing.

**APPLICATIONS** AKUSTUS panels are suitable for contract use and can be applied in a wide selection of public and private interior spaces including, but not limited to, the following: auditoriums, lecture halls, restaurants, offices, boardrooms, call centres, retail stores, hallways, fitness centres, classrooms, laboratories, phone booths, home theatres, and bedrooms.

**ADDITIONAL FEATURES** Tackable  
Mould & mildew resistant

# ACOUSTIC TEST DATA

NOISE REDUCTION COEFFICIENT [NRC]

**0.60**

SOUND ABSORPTION AVERAGE [SAA]

**0.58**

FREQUENCY [Hz]	100	125	160	200	250	315	400	500	630	800	1000	1250	1600	2000	2500	3150	4000	5000
ABSORPTION COEFFICIENTS [ $\alpha_s$ ]	0.01	0.04	0.07	0.10	0.12	0.18	0.30	0.44	0.63	0.72	0.81	0.87	0.91	0.94	0.97	0.98	0.97	0.98

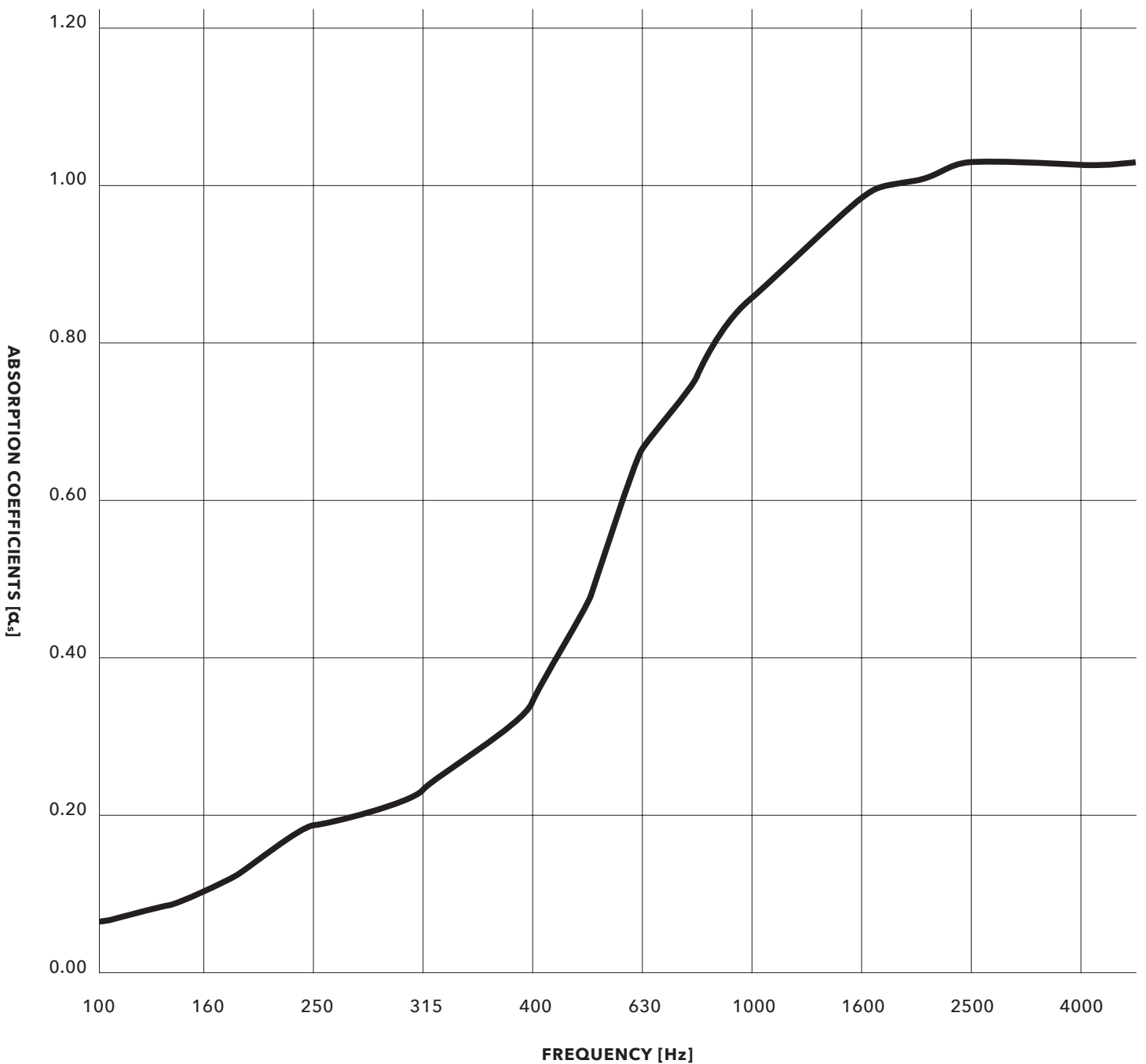

# COLOURS

## 18 MM COLOURS

The following 23 colours are available for panels with 18 mm thickness.

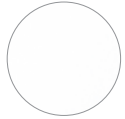

Pure White  
SP 07



Beige  
SP 04



Sandstone  
SP 12

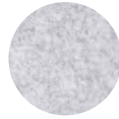

Pumice  
SP 11



Mid Grey  
SP 37

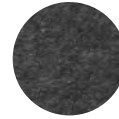

Graphite  
SP 03



Black  
SP 13



Peach  
SP 06



Red Earth  
SP 41



Wild Currant  
SP 48

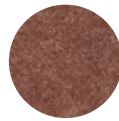

Vandyke Brown  
SP 39

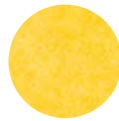

Sunflower  
SP 05



Orange  
SP 46



Yam  
SP 28



Red  
SP 08



Krypton  
SP 30



Chartreuse  
SP 43

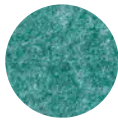

Green  
SP 10

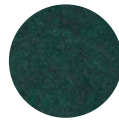

Forest Green  
SP 17



Sky Blue  
SP 25



Navy  
SP 01

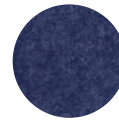

Midnight Blue  
SP 19



Purple  
SP 50

## 12 MM COLOURS

The following 8 colours are available for panels with 12 mm thickness.

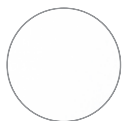

White  
AK 01

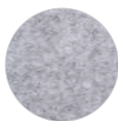

Gravel Grey  
AK 04

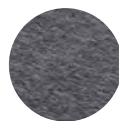

Slate  
AK 07

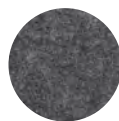

Graphite  
AK 05



Black  
AK 13

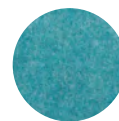

Teal  
AK 14

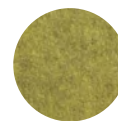

Olive  
AK 15



Rockies Brown  
AK 06

### Variations in Texture & Colour

Variations in the texture and colour from panel to panel are byproducts of the manufacturing process and are not considered defective.



# PRODUCT CARE

## HANDLING & STORAGE

Ensure that hands are clean prior to handling the panels. A panel longer and wider than one person should be lifted by two or more people. Panels should be stored in a dry, cool area away from sources of heat. Store panels by laying them flat on their faces as opposed to standing on their edges.

## MAINTENANCE

Vacuum to remove surface dust or use a mild, non-toxic soap with warm water to wipe away blots. Test the solution on an inconspicuous spot before applying to other areas and avoid saturating material.

## WARRANTY

AKUSTUS products are covered by a 1-Year Manufacturer Warranty against all defects. This warranty will be void if the product is altered or applied outside of its intended purpose.

