

Aero

BAFFLE

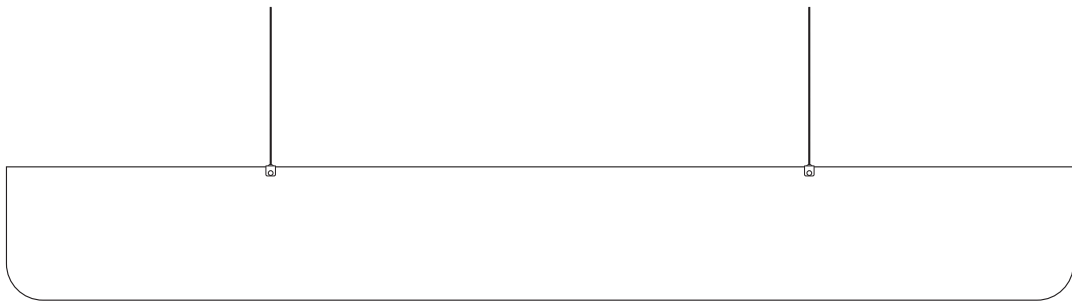

DESCRIPTION



Round and simple, the Aero baffle offers visual texture and audial clarity to any space it's suspended in. With brackets fastened to the top from which you can apply different connections, the baffle can easily be suspended from a variety of ceiling types.

DIMENSIONS

ANGLED

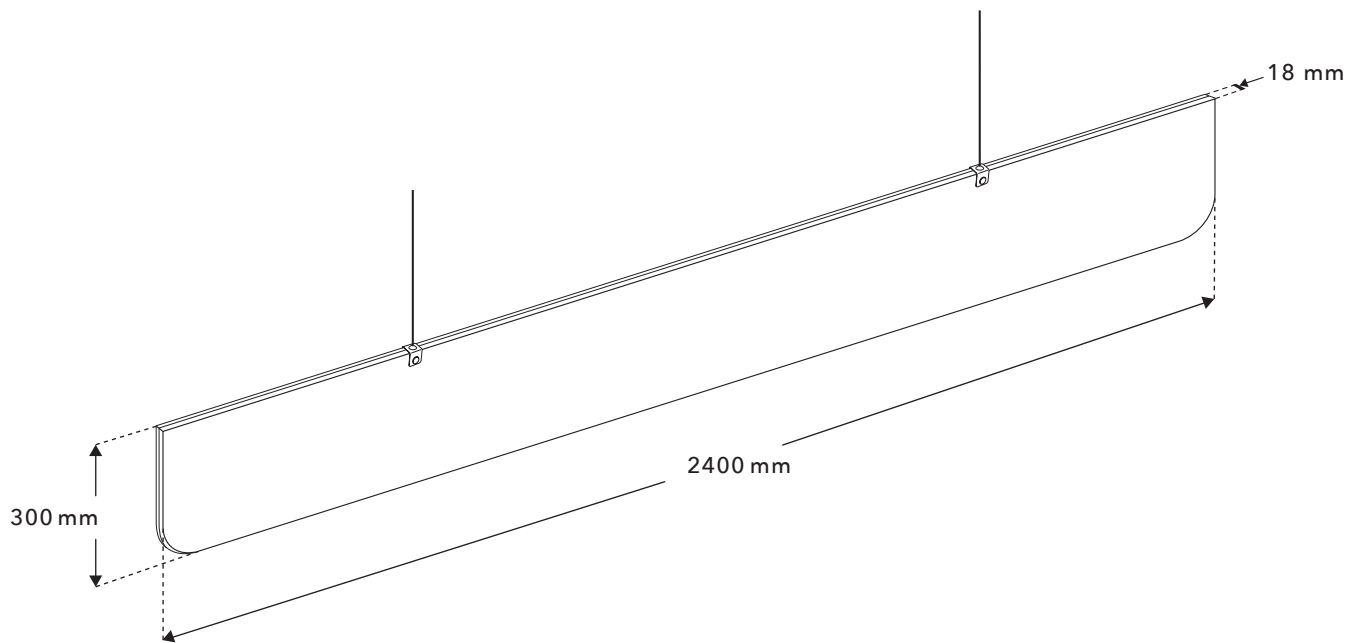

Installation

For details on suspension hardware and on how to install this product, please refer to the *Suspension Installation Guide*. Hardware not included with product. Hardware sold separately.

SPECIFICATIONS

PRODUCT NAME

Aero

COMPOSITION

100% polyester fibre

DIMENSIONS

2400 mm x 300 mm

THICKNESS18 mm (*alternative thicknesses available on request*)**MIN. SIZE**

600 mm x 150 mm

MAX. SIZE

2400 mm x 1200 mm

WEIGHT7 lbs (*hardware not included*)**EDGE DETAIL**

Straight

ACOUSTIC PROPERTIES

ASTM C423 (NRC): 0.85-1.00

FIRE RATING

CAN/ULC S102.2-10

ENVIRONMENTAL

AKUSTUS panels are made from approximately 50% recycled content originating from recycled water bottles. The panels are 100% recyclable, free of toxic substances and free of off-gassing.

APPLICATIONS

AKUSTUS panels are suitable for contract use and can be applied in a wide selection of public and private interior spaces including, but not limited to, the following: auditoriums, lecture halls, restaurants, offices, boardrooms, call centres, retail stores, hallways, fitness centres, classrooms, laboratories, phone booths, home theatres, and bedrooms.

ADDITIONAL FEATURES

Tackable
Mould & mildew resistant

COLOURS

18 MM / 12 MM COLOURS

The following 14 colours are available in 18 mm and 12 mm thickness.



Pure White
SP 07



Beige
SP 04



Sandstone
SP 12

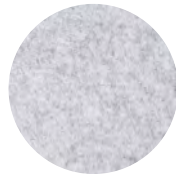

Pumice
SP 11

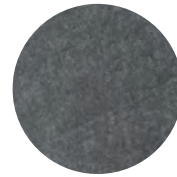

Mid Grey
SP 37



Graphite
SP 03



Black
SP 13

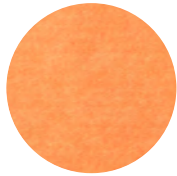

Orange
SP 46

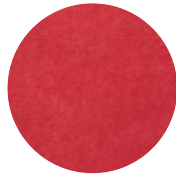

Red
SP 08



Krypton
SP 30

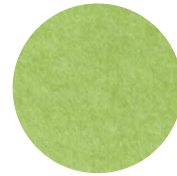

Chartreuse
SP 43

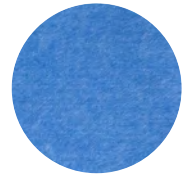

Sky Blue
SP 25



Navy
SP 01

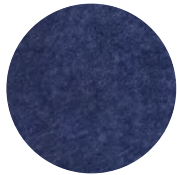

Midnight Blue
SP 19

18MM COLOURS ONLY

The following 9 colours are available in 18 mm thickness.



Peach
SP 06

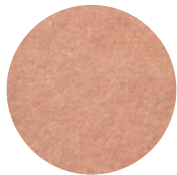

Red Earth
SP 41



Wild Currant
SP 48

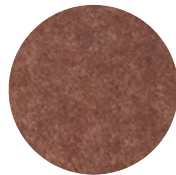

Vandyke Brown
SP 39

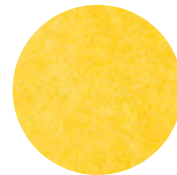

Sunflower
SP 05

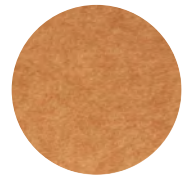

Yam
SP 28

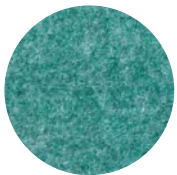

Green
SP 10



Forest Green
SP 17



Purple
SP 50

Variations in Texture & Colour

Variations in the texture and colour from panel to panel are byproducts of the manufacturing process and are not considered defective.

PRODUCT CARE

HANDLING & STORAGE

Ensure that hands are clean prior to handling the panels. A panel longer and wider than one person should be lifted by two or more people. Panels should be stored in a dry, cool area away from sources of heat. Store panels by laying them flat on their faces as opposed to standing on their edges.

MAINTENANCE

Vacuum to remove surface dust or use a mild, non-toxic soap with warm water to wipe away blots. Test the solution on an inconspicuous spot before applying to other areas and avoid saturating material.

WARRANTY

AKUSTUS products are covered by a 1-Year Manufacturer Warranty against all defects. This warranty will be void if the product is altered or applied outside of its intended purpose.

