

Square Small

PANEL

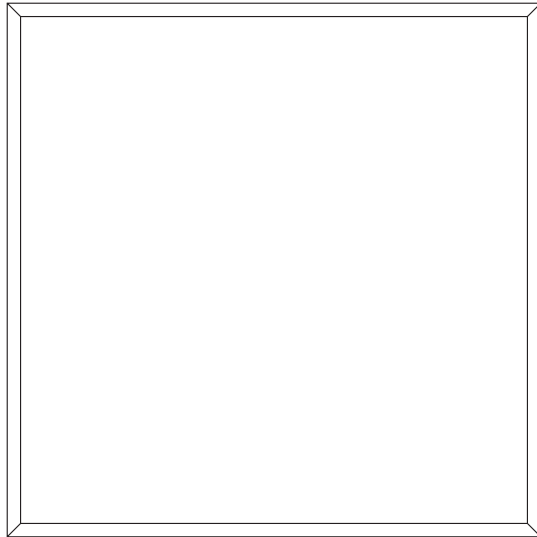

DESCRIPTION



Simple but versatile, the Square panel improves the acoustics and the aesthetics of any space it adorns. The panel can easily be installed on to a variety of surfaces through the use of adhesive.

DIMENSIONS

FRONT

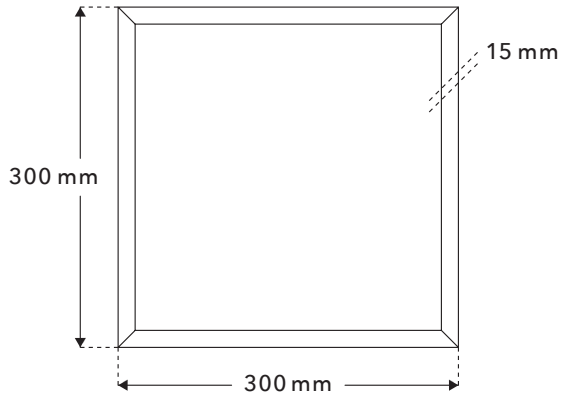

SIDE

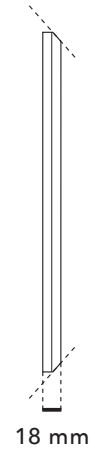

ANGLED

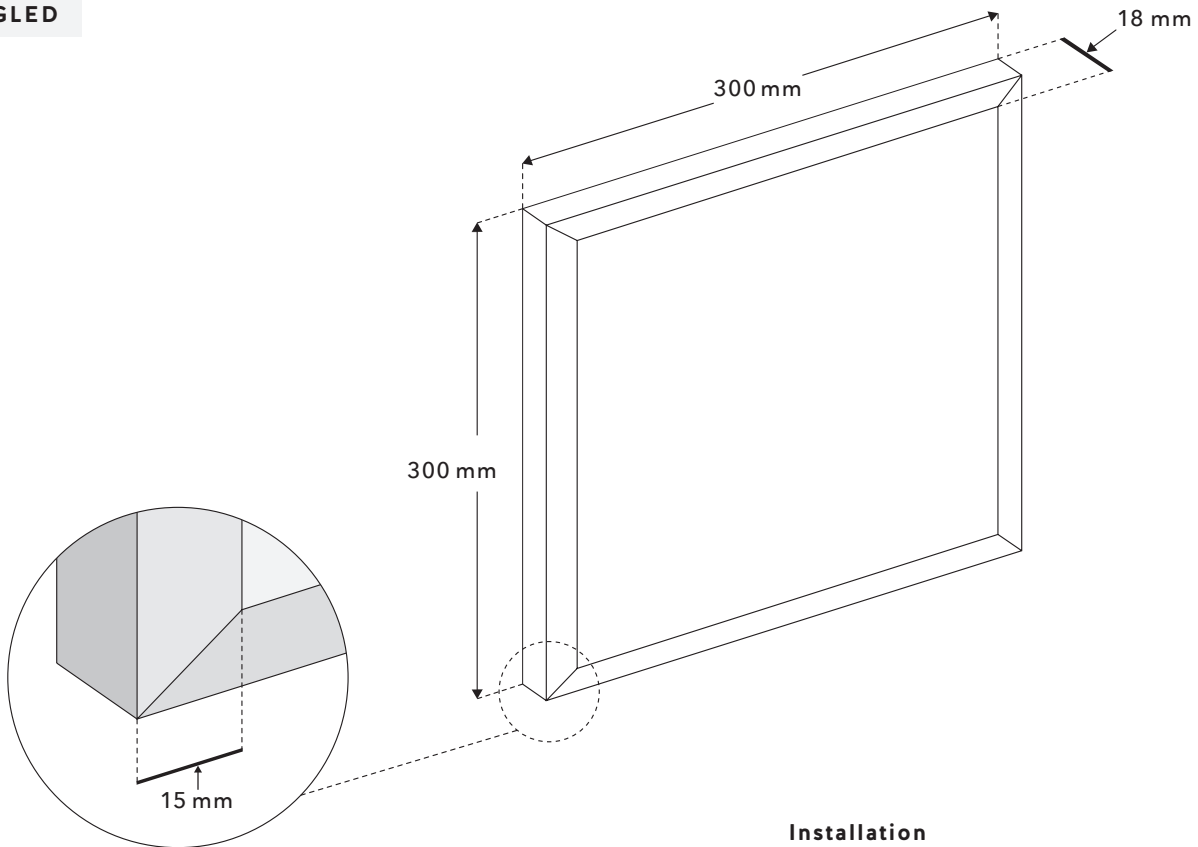

Installation

For details on how to install this product, please refer to the *Adhesive Installation Guide*.

SPECIFICATIONS

PRODUCT NAME Square Small

COMPOSITION 100% polyester fibre

DIMENSIONS 300 mm x 300 mm

THICKNESS 18 mm (*alternative thicknesses available on request*)

MIN. SIZE 150 mm x 150 mm

MAX. SIZE 1200 mm x 1200 mm

WEIGHT 1 lb

EDGE DETAIL Bevelled (*straight edge available*)

ACOUSTIC PROPERTIES ASTM C423 (NRC): 0.60

FIRE RATING CAN/ULC S102.2-10

ENVIRONMENTAL

AKUSTUS panels are made from approximately 50% recycled content originating from recycled water bottles. The panels are 100% recyclable, free of toxic substances and free of off-gassing.

APPLICATIONS

AKUSTUS panels are suitable for contract use and can be applied in a wide selection of public and private interior spaces including, but not limited to, the following: auditoriums, lecture halls, restaurants, offices, boardrooms, call centres, retail stores, hallways, fitness centres, classrooms, laboratories, phone booths, home theatres, and bedrooms.

ADDITIONAL FEATURES

Tackable
Mould & mildew resistant

ACOUSTIC TEST DATA

NOISE REDUCTION COEFFICIENT [NRC]

0.60

SOUND ABSORPTION AVERAGE [SAA]

0.58

FREQUENCY [Hz]	100	125	160	200	250	315	400	500	630	800	1000	1250	1600	2000	2500	3150	4000	5000
ABSORPTION COEFFICIENTS [α_s]	0.01	0.04	0.07	0.10	0.12	0.18	0.30	0.44	0.63	0.72	0.81	0.87	0.91	0.94	0.97	0.98	0.97	0.98

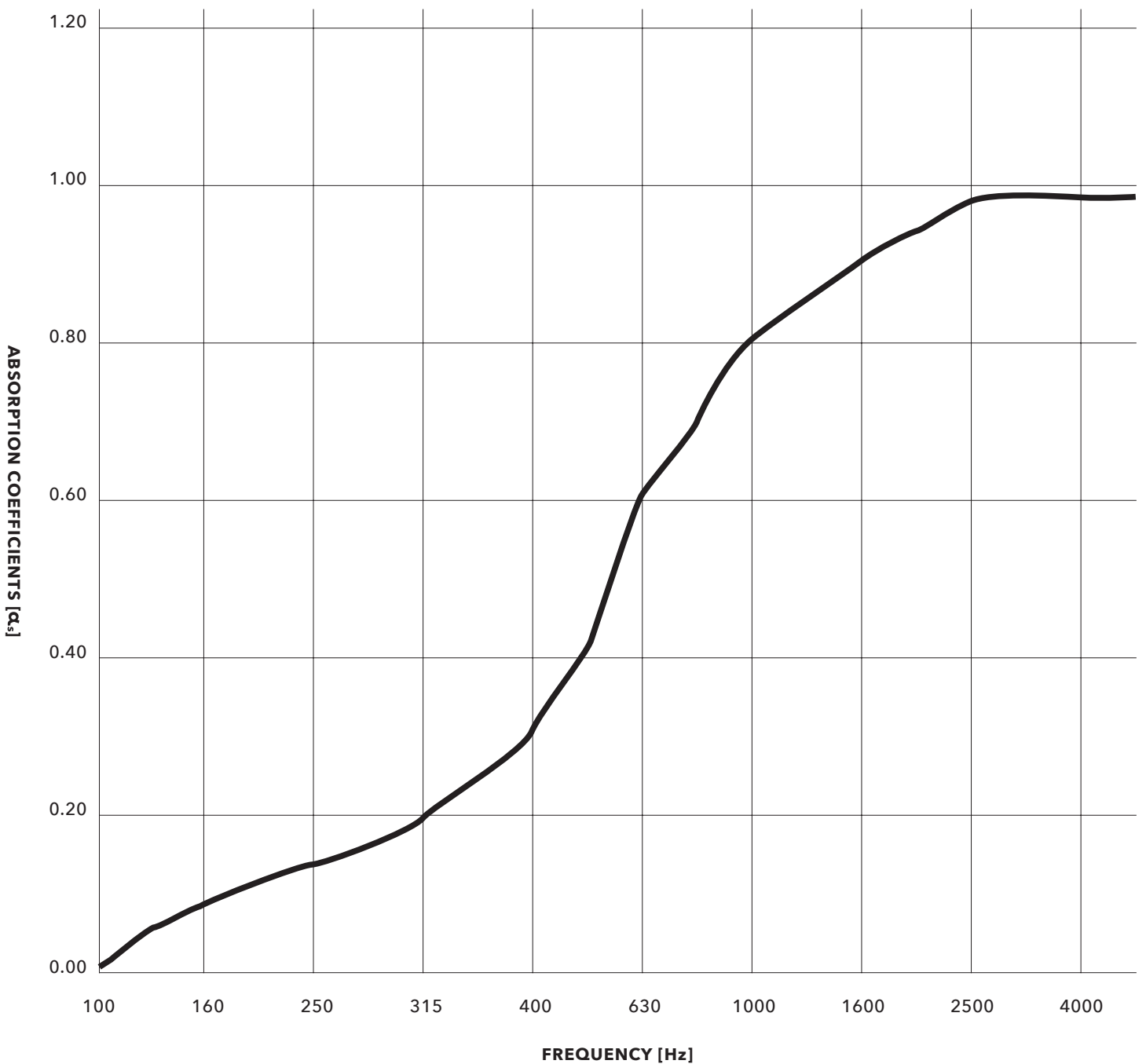

COLOURS

18 MM / 12 MM COLOURS

The following 14 colours are available in 18 mm and 12 mm thickness.



Pure White
SP 07



Beige
SP 04



Sandstone
SP 12

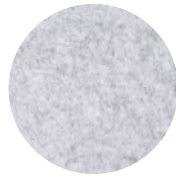

Pumice
SP 11

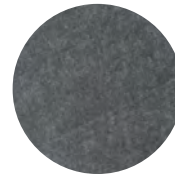

Mid Grey
SP 37

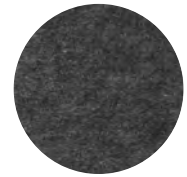

Graphite
SP 03



Black
SP 13

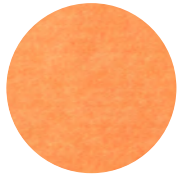

Orange
SP 46

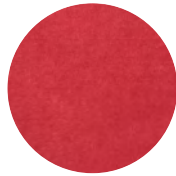

Red
SP 08



Krypton
SP 30

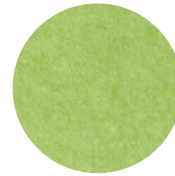

Chartreuse
SP 43

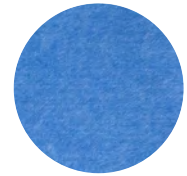

Sky Blue
SP 25



Navy
SP 01

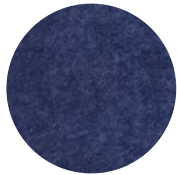

Midnight Blue
SP 19

18MM COLOURS ONLY

The following 9 colours are available in 18 mm thickness.



Peach
SP 06



Red Earth
SP 41



Wild Currant
SP 48

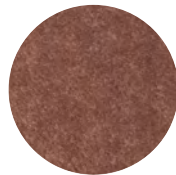

Vandyke Brown
SP 39

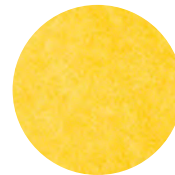

Sunflower
SP 05

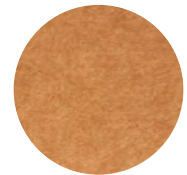

Yam
SP 28

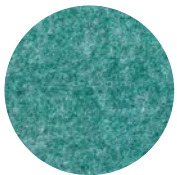

Green
SP 10

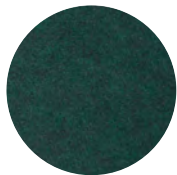

Forest Green
SP 17



Purple
SP 50

Variations in Texture & Colour

Variations in the texture and colour from panel to panel are byproducts of the manufacturing process and are not considered defective.

PRODUCT CARE

HANDLING & STORAGE

Ensure that hands are clean prior to handling the panels. A panel longer and wider than one person should be lifted by two or more people. Panels should be stored in a dry, cool area away from sources of heat. Store panels by laying them flat on their faces as opposed to standing on their edges.

MAINTENANCE

Vacuum to remove surface dust or use a mild, non-toxic soap with warm water to wipe away blots. Test the solution on an inconspicuous spot before applying to other areas and avoid saturating material.

WARRANTY

AKUSTUS products are covered by a 1-Year Manufacturer Warranty against all defects. This warranty will be void if the product is altered or applied outside of its intended purpose.

